

Test four

- 1 Which is the odd one out?

CLAVICHORD, SPINET, HARPSICHORD, CLARION,
ACCORDION

- 2 'SLOW OR FAST ROADS' is an anagram of which familiar phrase: 2, 1, 4, 3, 5, which means the opposite of verbose?

At a loss for words

- 3 586321 is to 268
as 94783219647 is to ?

46284

- 4 What do the following have in common?

RHAPSODY IN BLUE
QUICK ON THE DRAW
BOXING MATCHES
WHISKY GALORE
VENUS FLYTRAP
QUESTION MARK
PANTY GIRDLES

*None of them
repeat a letter.*

5 Shields

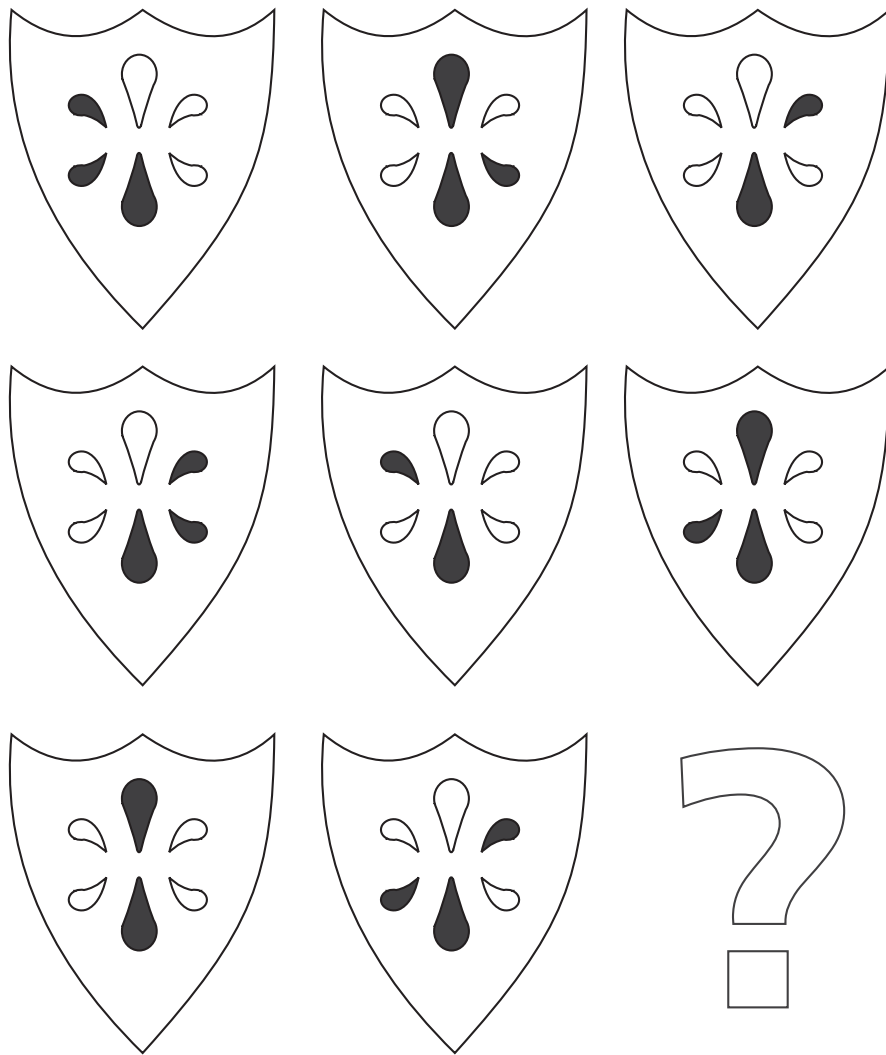

Which shield should replace the question mark?

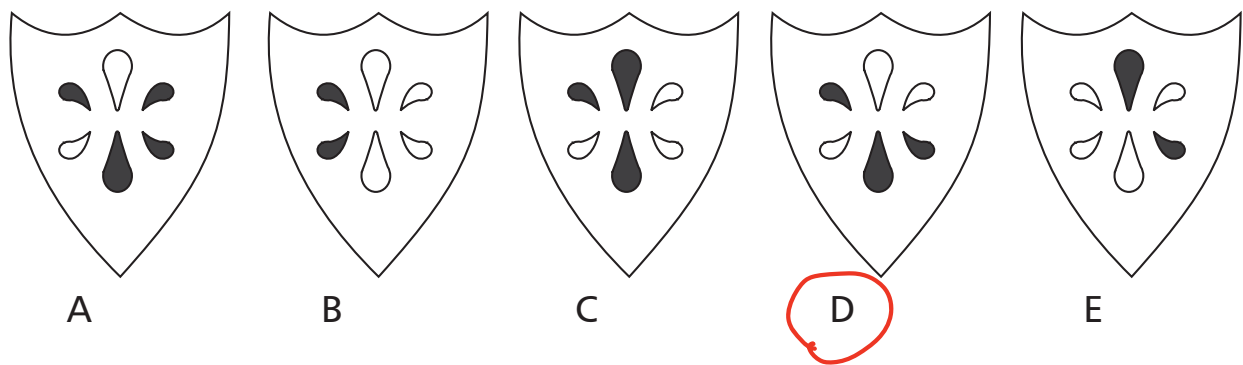

48 Test Your IQ

- 6 Spiral clockwise round one of the circles and anti-clockwise round the other to find two words that have similar meanings.

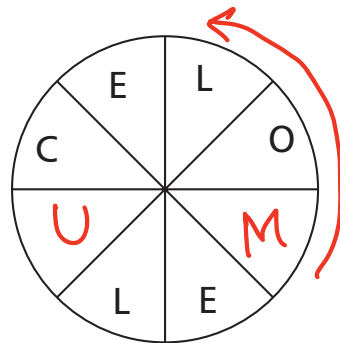

Molecule

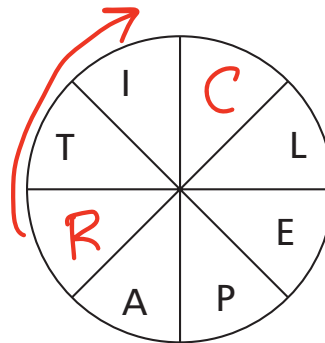

particle

- 7 LATTICE : WINDOW

Which two words below have the same relationship as the two words above?

- a) portal : gable
 - b) embrasure : chimney
 - c) mansard : roof
 - d) parapet : door
 - e) fascia : floor
- 8 Which word in brackets means the same as the word in capitals?

INDISCRETION (crudity, sloth, folly, aversion, vacillation)

9 What numbers should replace the question marks?

	7	5	4	6
	← +2	← +1	← -2	
-2	↓		← -2	← 8
	5	8	10	8
+1	↓	↓ +1		↑
	6	9	11	7
+2	↓		← +2	↑
	8	6	7	9

10 What do the following words have in common?

PRECIOUS, CIRCLE, TONE, AUTOMATIC

the all can start with semi

11 A well-known phrase has had all its vowels removed and has been split into groups of three letters, which are in the correct order. What is the phrase?

KPT HBL LRL LNG

keep the ball rolling

12 What is the missing number?

	1	1	2	1	
	2	7	6	8	4
	1	2	1	9	6
	2	5	4	7	8
	+				
	6	5	3	5	8

13 What comes next?

A, 1A, 111A, 311A, ?

132 11A

① ③ ②

ويف احد رقم 1 في المتوسطة

50 Test Your IQ

14 Complete two magic word squares where the same four words in each square can be read both vertically and horizontally. Clues are given, but in no particular order.

D	A	M	P			
A	R	E	A			
M	E	W	S			
P	A	S	T	I	M	E
			I	D	O	L
			M	O	S	S
			E	L	S	E

- Clues:
1. Dense plant
 2. Yard or street
 3. Stretch of land
 4. Moist
 5. Someone in addition
 6. Figure of worship

15 Comparison

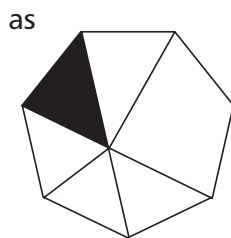
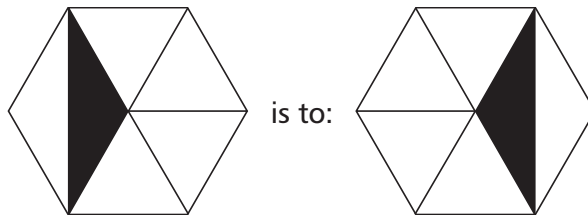

is to:

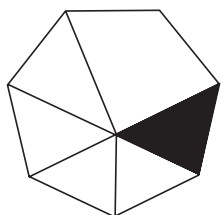

A

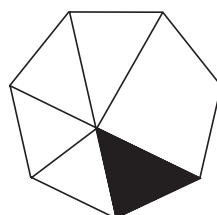

B

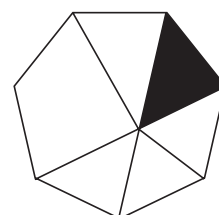

C

16 Which is the odd one out?

SALIFEROUS, EVACUATION, REGULATION,
EXHAUSTION, INOCULATED, DUODECIMAL

17 Which number is the odd one out?

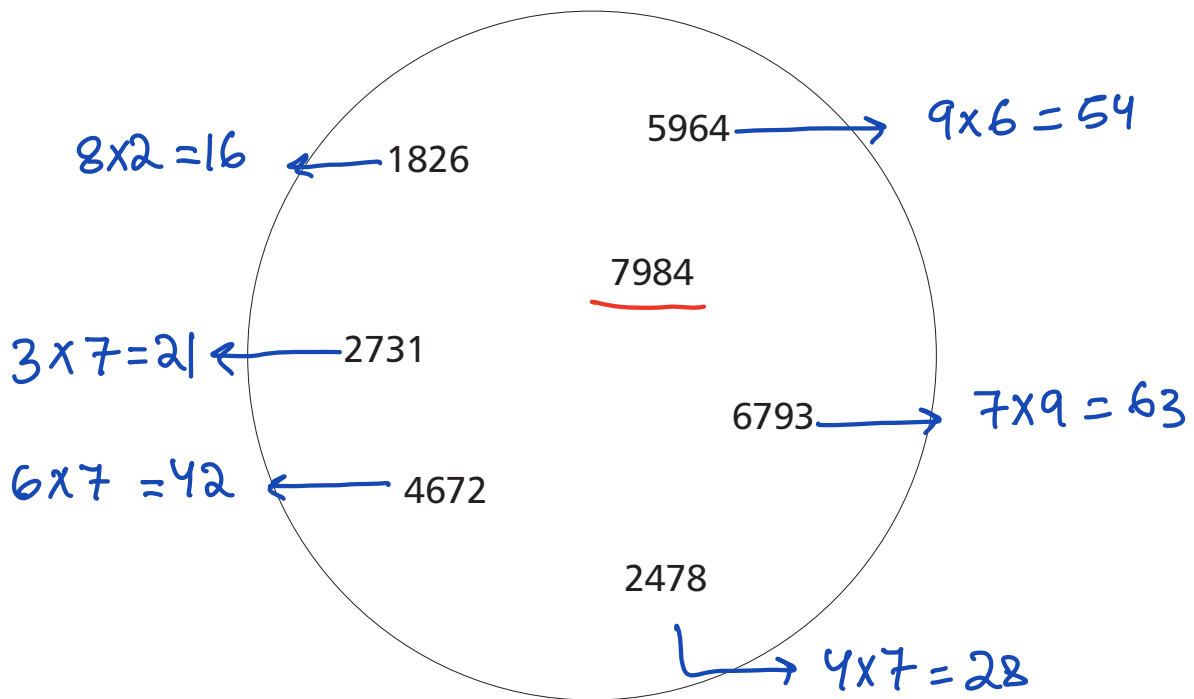

18 Which two words are most opposite in meaning?

MALICIOUS, KNAVISH, HOPEFUL, SERVILE, PRINCIPLED,
AWKWARD

52 Test Your IQ

19 Which other 12-letter weather phrase can be placed in the right-hand column in order to complete the three-letter words reading across?

H	A	T
I		h
G		U
H	E	n
P	A	d
R	U	e
E	A	r
S		S
S	I	t
U		O
R		r
E	L	m

Thunder Storm

(7, 5)

20 I strode to Dorset, ate milk and rice in Limerick and bought Edna a beer in Aberdeen. Whom did I meet in Antrim?

Martin

21 Insert a word that means the same as the words outside the brackets.

SKIN (hide) CONCEAL

22 Replace the dots with a word to make five new words.

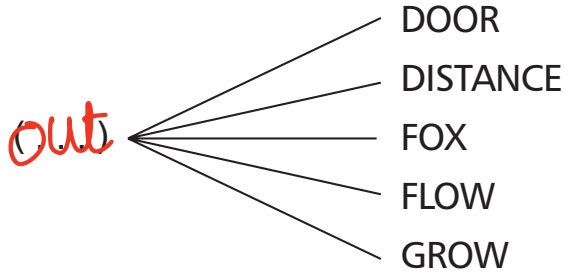

23 Which number should replace the question mark?

مجموع كل رقم الرقم المقابل له يحسبوا 12

$7+5=12$

$4+8=12$

$12-3=9$

24 What is the name given to a group of HORSES?

- a) husk
- b) haras**
- c) mute
- d) rush
- e) sord

25 Comparison

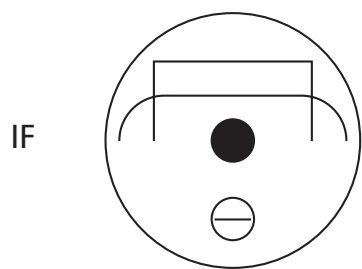

IS TO:

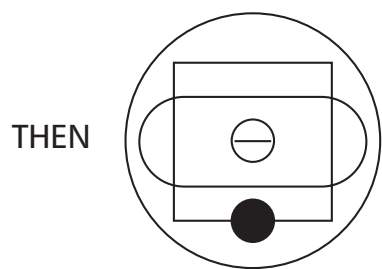
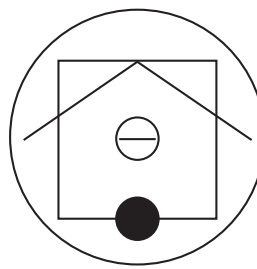

IS TO:

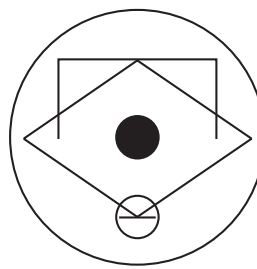

A

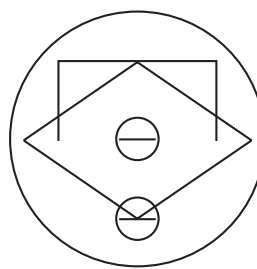

B

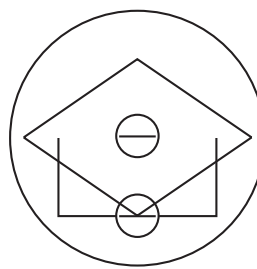

C

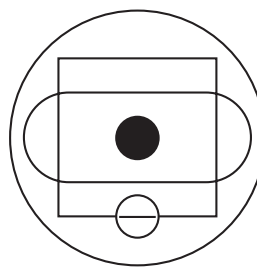

D

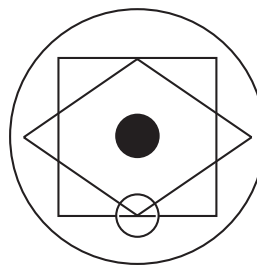

E

26 Fill in the blanks, clockwise or anti-clockwise, to form two words that are synonyms.

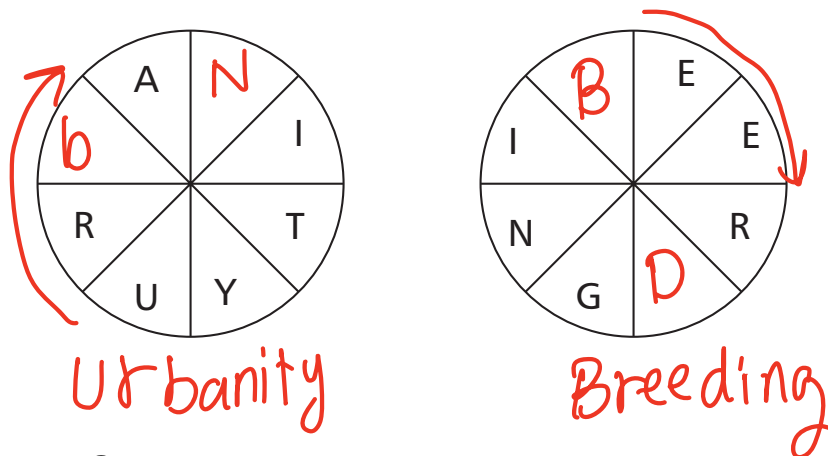

27 What is an ORRERY?

- a) a clockwork model
- b) a Florentine iris
- c) a golden ornament
- d) a museum
- e) a dungeon

28 What is the value of x?

$$\frac{17}{19} \div \frac{3}{38} = x \rightarrow \frac{34}{3}$$

29 Which one of these is not an animal?

- LAWSEE
- GADBER
- DIHRAS
- MACYAN
- ROUGAC

30 Hexagon

Which hexagon, A, B, C, D or E, fits the missing space?

	X	Y	Z
1			
2			
3			

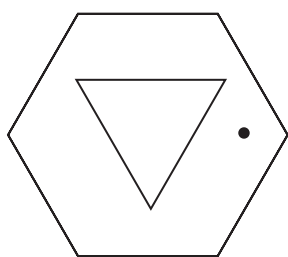

A

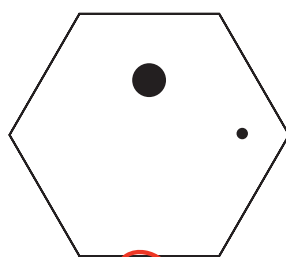

B

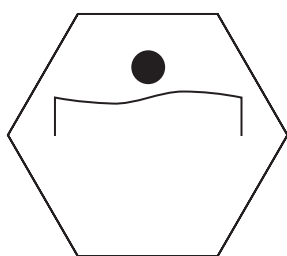

C

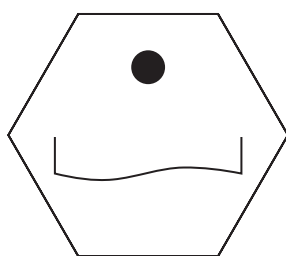

D

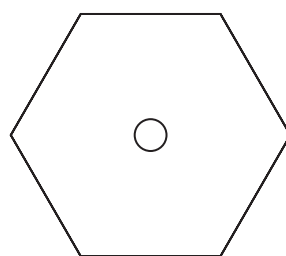

E

31 What number should replace the question mark?

$$\begin{array}{r} (16-4) \\ (3+3)^x \\ \hline 72 \end{array}$$

16		3
	72	
3		4

17		8
	160	
2		1

14		8
	?	
4		3

132

$$\begin{array}{r} (14-3) \\ (8+4)^x \\ \hline 132 \end{array}$$

32 Solve the one-word anagram.

NO MORE STARS

Astronomers

33 Which two words mean the same?

ADVOCATE, LAMPOON, MEDIATE, DEFAME, PROJECT, ARBITRATE

34 Replace the dots with a word to make five new words.

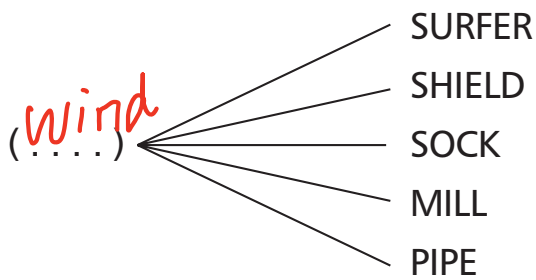

35 Symbols

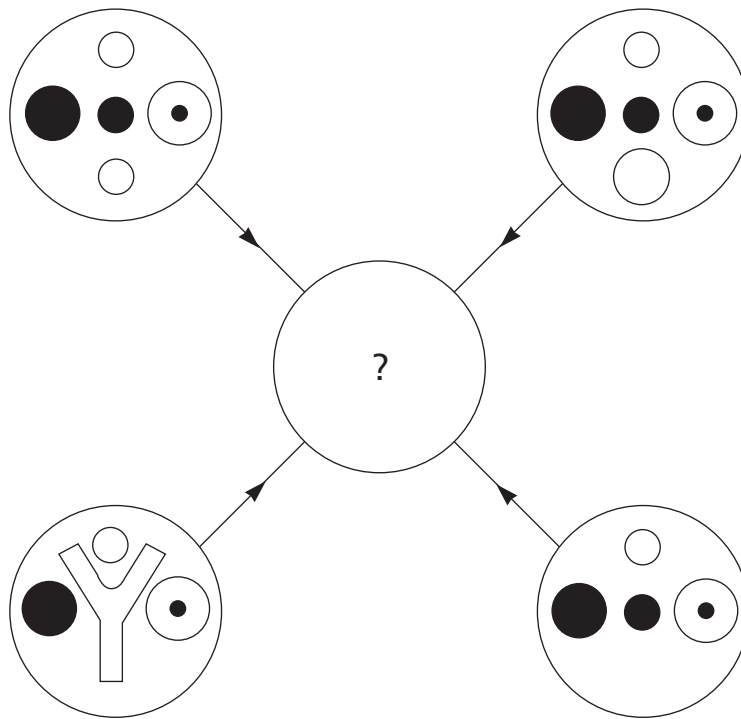

Each line and symbol that appears in the four outer circles, above, is transferred to the centre circle according to these rules:

if a line or symbol occurs in the outer circles:

- once: it is transferred
- twice: it is possibly transferred
- 3 times: it is transferred
- 4 times: it is not transferred

Which of the circles A, B, C, D or E, shown below, should appear at the centre of the diagram, above?

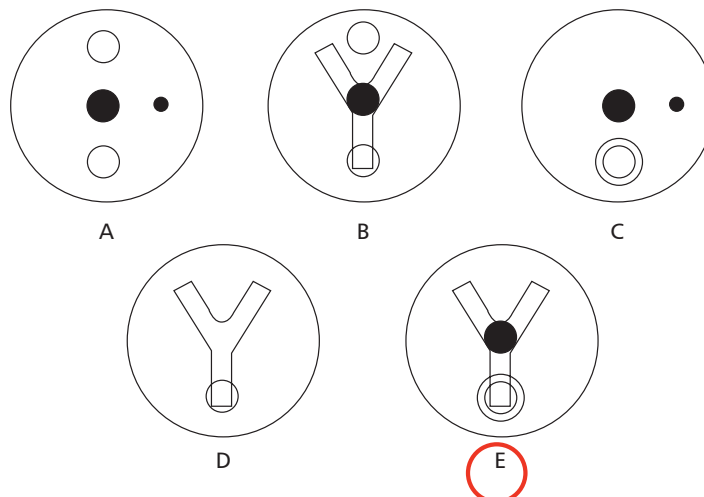

36 What is a HARBINGER?

- a) a flowering shrub
- b) a type of boat
- c) a messenger**
- d) a cloak
- e) a drink

37 Fill in the blanks, clockwise or anti-clockwise, to complete the words.

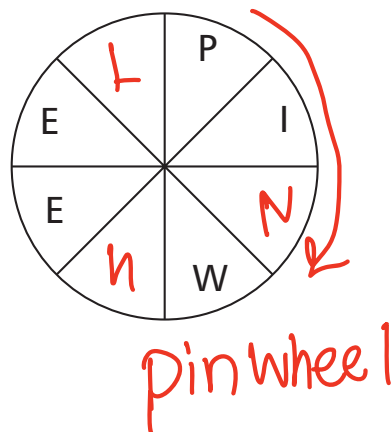

38 What is the value of x?

$$3 - 6 \times 7 + 6 \div 4 = x \quad -37.5$$

39 Place three two-letter bits together to make an ANIMAL.

EY – CK – DO – AT – RR – ES – NK – FE – JA

Donkey

40 Grid

Each of the nine squares in the grid marked 1A to 3C should incorporate all the lines and symbols that are shown in the squares of the same letter and number immediately above and to the left. For example, 2B should incorporate all the lines and symbols that are in 2 and B.

One of the squares is incorrect. Which one is it?

	A	B	C
1	1A	1B	1C
2	2A	2B	2C
3	3A	3B	3C

Test five

1 How many circles appear below?

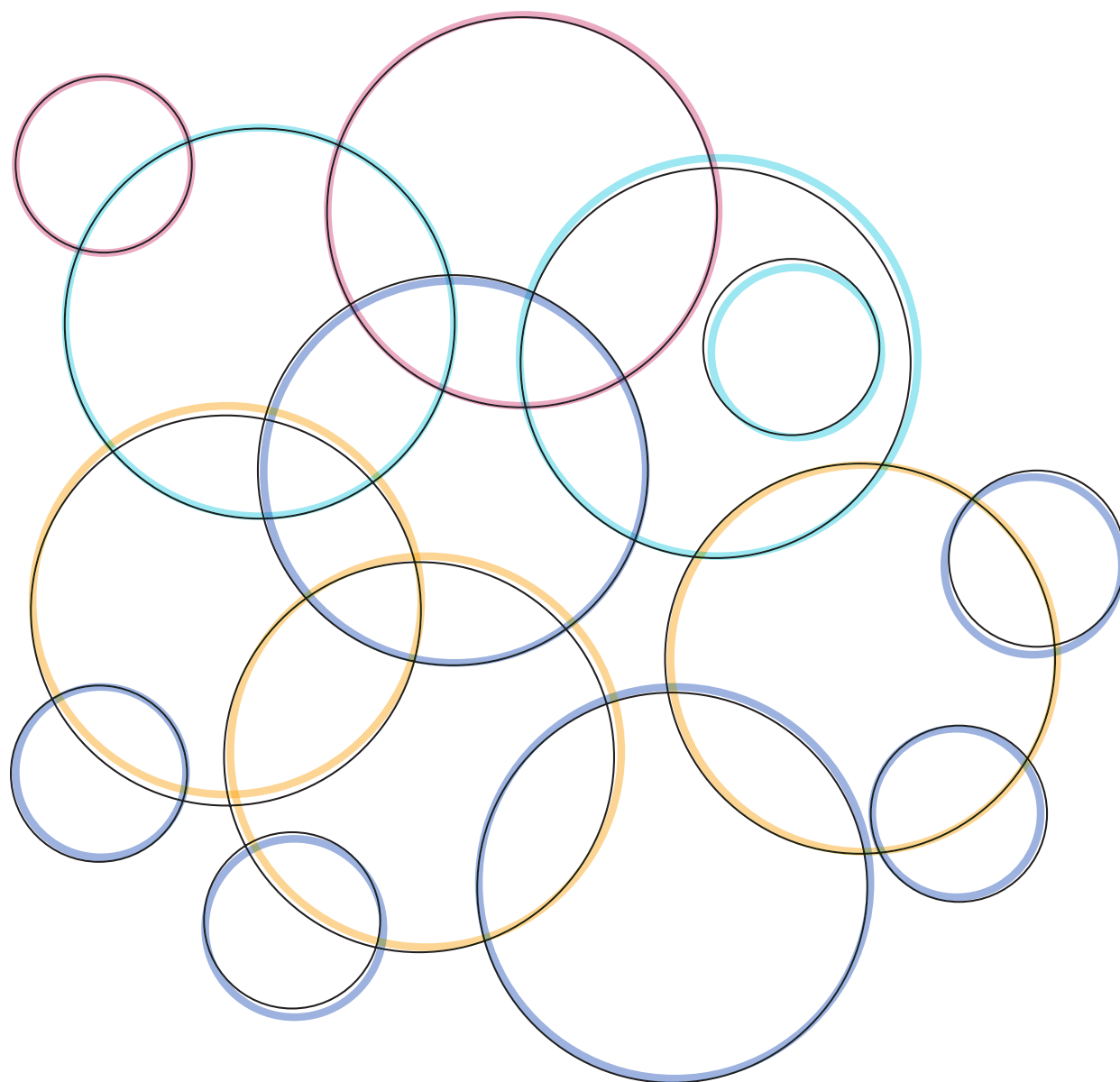

14

- 2 Complete the six words so that two letters are common to each word. That is, reading across, the same two letters that end the first word also start the second word, etc. The two letters that end the sixth word are also the first two letters of the first word, to complete the circle.

ENABIE
 LENGTH
 THIEVE
 VENDOR
 ORACLE
 LESSEN

$$\text{Rate} = \frac{1}{\text{Time}}$$

$$\text{Hot rate} = \frac{1}{3}$$

$$\text{Cold rate} = \frac{1}{2}$$

$$\text{Drain rate} = \frac{1}{6}$$

$$\begin{aligned} \text{total} &= \frac{1}{3} + \frac{1}{2} - \frac{1}{6} \\ &= \frac{2}{3} \\ \text{Time} &= \frac{1}{\text{Rate}} = \frac{1}{\frac{2}{3}} \\ &= \frac{3}{2} = 1.5 \end{aligned}$$

- 3 You have accidentally left the plug out of the bath and are attempting to fill the bath with both taps full on. The hot tap takes three minutes to fill the bath and the cold tap two minutes, and the water empties through the plug hole in six minutes. In how many minutes will the bath be filled?

$$\frac{3}{2} = 1.5 \text{ minutes}$$

- 4 Sequence

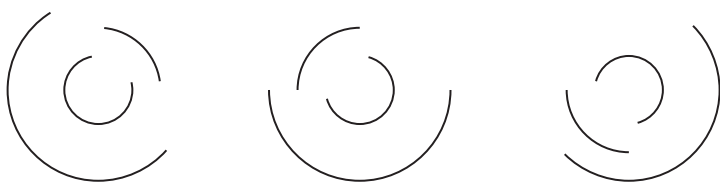

What continues the above sequence?

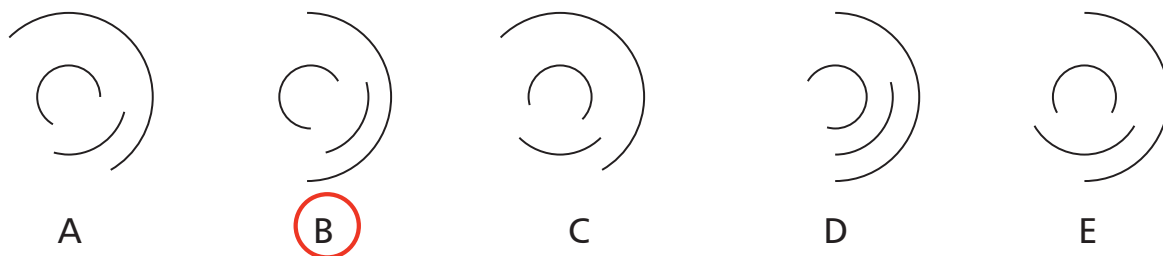

A

B

C

D

E

5 Which word is the odd one out?

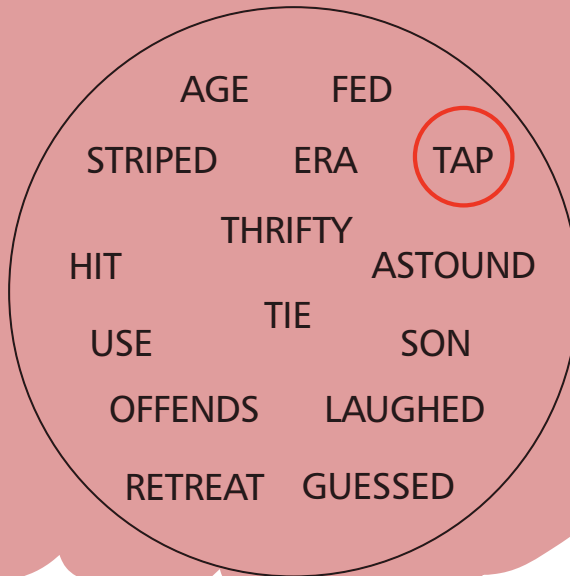

6 What number should replace the question mark?

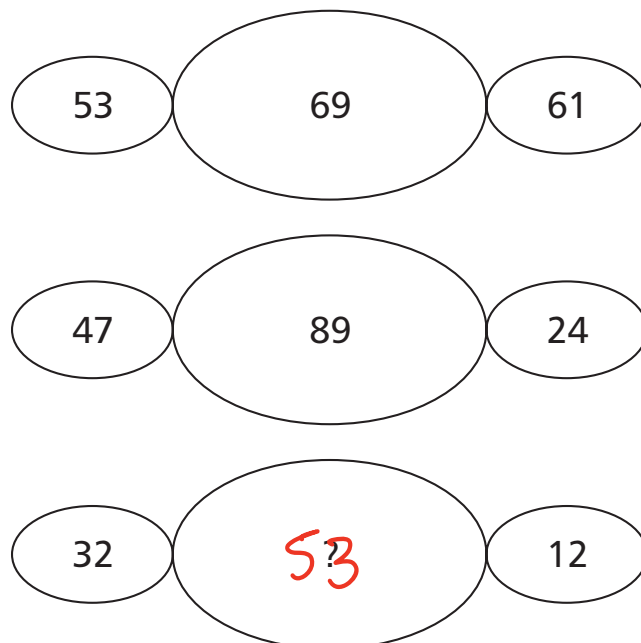

7 What do these words have in common?

ABUNDANCE, ALLEVIATE, UNTRUTHS, PROCAINE,
CHAMBER

have Biblical characters

8 What letter should replace the question mark?

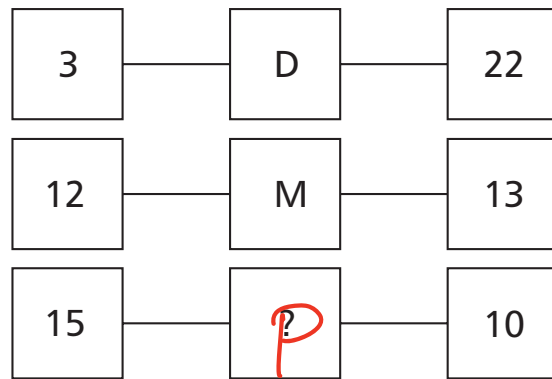

9 Solve the anagram in brackets to complete the quotation correctly. You are looking for a two-word answer (5, 6).

Clue: convenience

The (FUTILE SLOTH) is the basis of western civilization (Alan Coult).

Flush toilet

10 Sequence

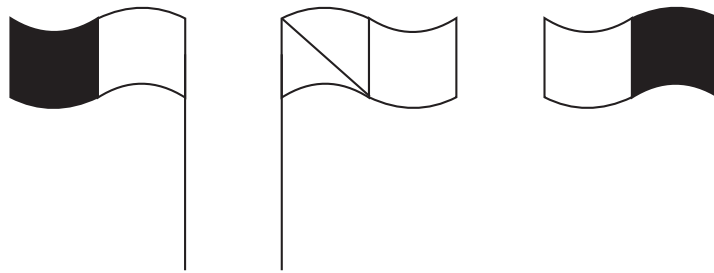

What comes next in the above sequence?

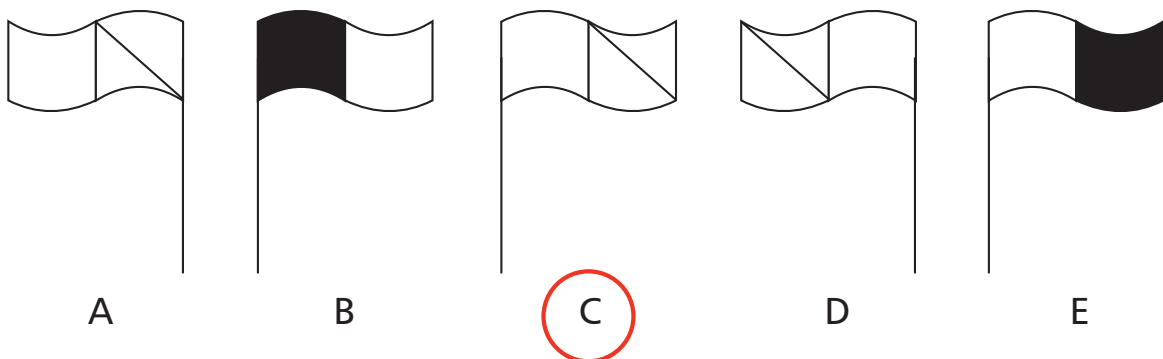

11 Insert the numbers 1–5 in the circles so that for any particular circle the sum of numbers in the circles connected directly to it equals the value corresponding to the number in that circle, as given in the list.

Example:

1 = 14 (4+7+3)

4 = 8 (7+1)

7 = 5 (4+1)

3 = 1

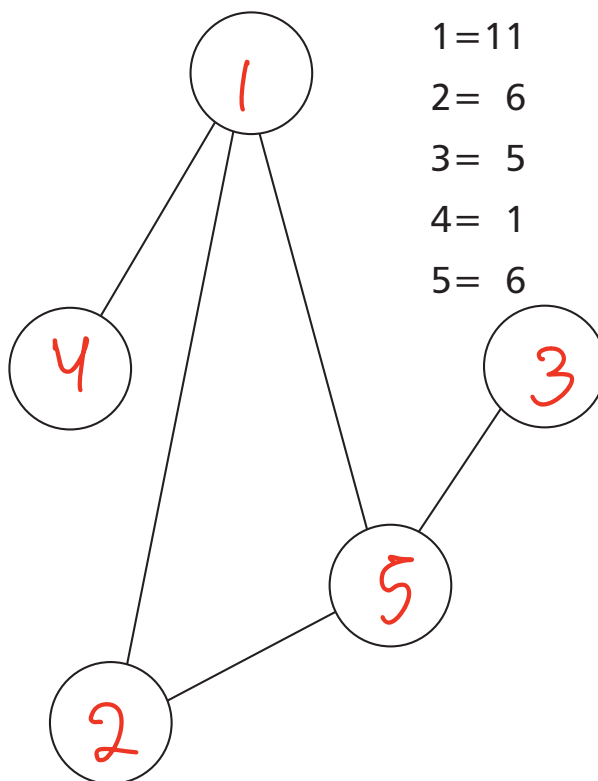

66 Test Your IQ

12 Pick a letter from each circle and, reading anti-clockwise, spell out two words that are synonyms. Each word starts in a different circle.

Fragrant
Aromatic

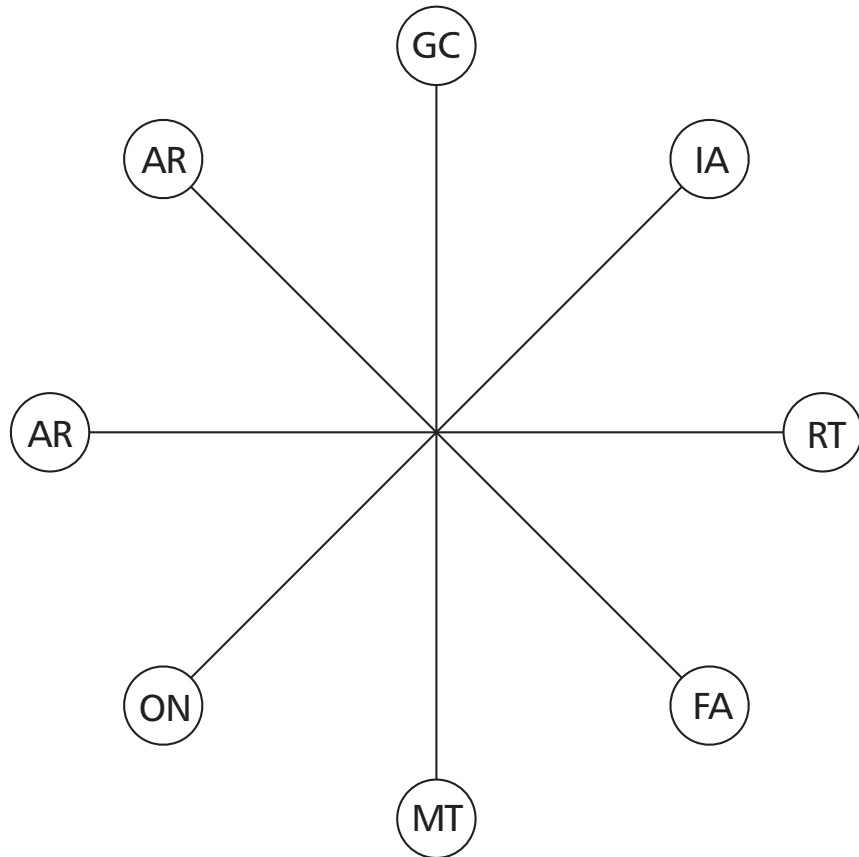

13 Create two words using the following ten letters each once only:

Clue: easier tariff

MXERPLAITS

Simpler tax

14 MUSIC: COMPOSE

- DEVICE:
- a) use
 - b) create
 - c) construct
 - d) invent**
 - e) change

15 Find two of the three words that will form an anagram synonymous with the word remaining.

Example: LEG – MEEK – NET = MEEK – GENTLE (LEG, NET)

TRUCE – NONE – MEET

encounter

16 What number continues this sequence?

987, 251, 369, 872, 513, ? 698

17 Move horizontally and vertically, but not diagonally, to spell out a 12-letter word. You must provide the missing letters.

E	F	O	R
S	O	N	P
S	I	A	L

professional

18 What comes next in this sequence?

7, 8, 9, 10, 12, 14, 16, 20, 21, 28, ? 27

+2 +3 +4 +5 +6

19 Which two words are closest in meaning?

EXPLORER, VAGRANT, MINSTREL, RESIDENT, SOLDIER, ITINERANT

20 Change one letter only from each word to find a familiar phrase:

OUT OF IRE

put on ice

68 Test Your IQ

21 Which one of these is not a vegetable?

ROCART

EYECLR

ROMRAW

TOPAOT

• XESTTE

22 What number should replace the question mark?

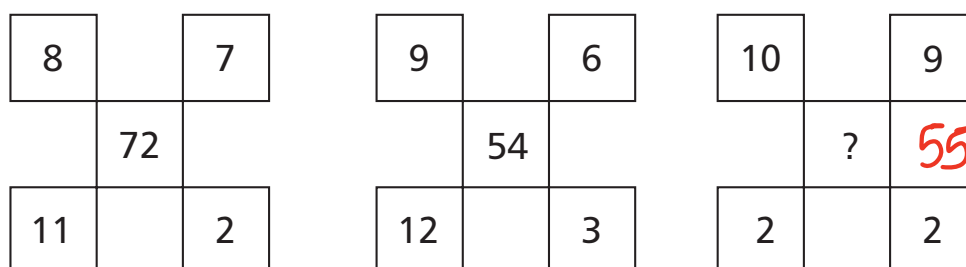

23 Replace the dots with a word to make five new words.

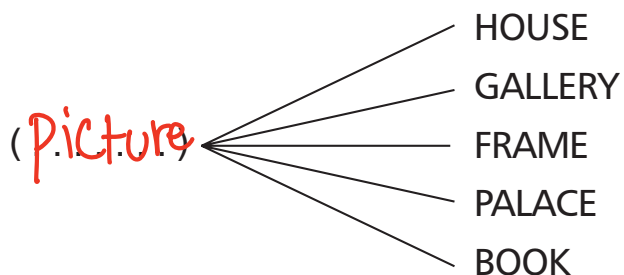

24 What is the name given to a group of BUTLERS?

a) blast

b) host

c) draught

d) morbidity

e) staff

25 Circles

Which of A, B, C, D or E fits into the blank circle to carry on a logical sequence?

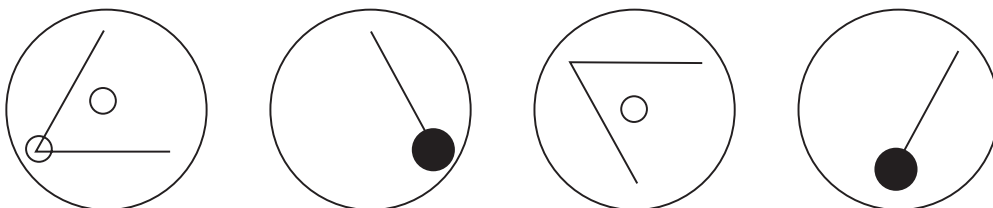
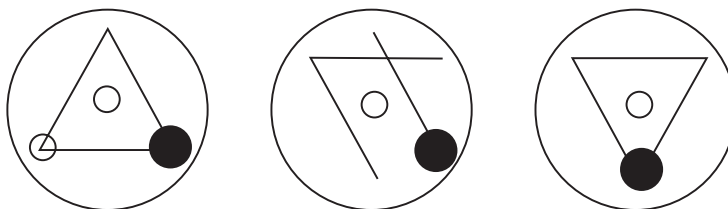
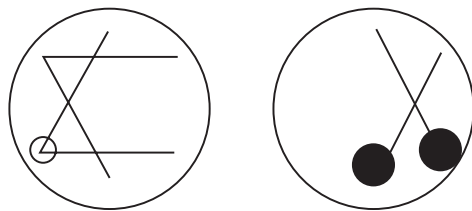
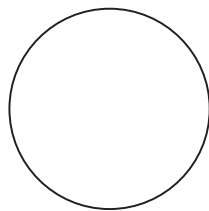
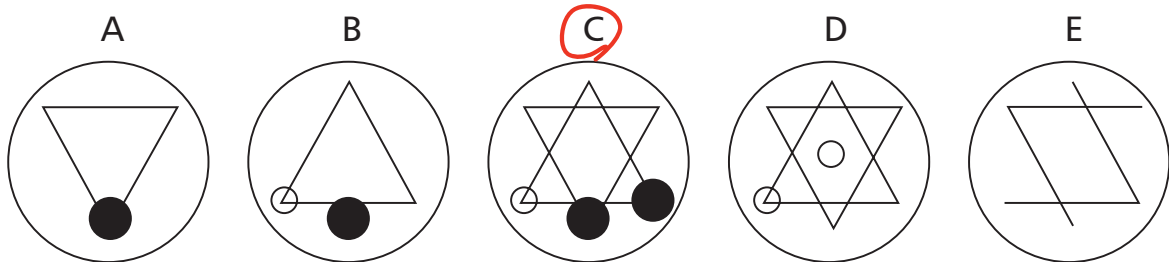

26 What is a CURRICLE?

- a) a vehicle
- b) a boat
- c) a curtain
- d) French dressing
- e) a vegetable

70 Test Your IQ

27 Fill in the blanks to complete the word, clockwise or anti-clockwise.

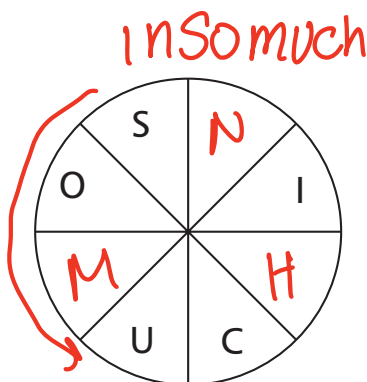

28 Insert a word that means the same as the words outside the brackets.

BE EVASIVE (*Hedge*) BUSHES

29 Make a six-letter word using only these four letters.

L O

G I

Gigolo

30 Grid

Each of the nine squares in the grid marked 1A to 3C should incorporate all the lines and symbols that are shown in the squares of the same letter and number immediately above and to the left. For example, 2B should incorporate all the lines and symbols that are in 2 and B.

One of the squares is incorrect. Which one is it?

	A	B	C
1	1A	1B	1C
2	2A	2B	2C
3	3A	3B	3C

72 Test Your IQ

31 Which word means the same as NEGATORY?

- a) fallacious
- b) prodigious
- c) trifling
- d) restraining

32 Fill in the blanks to form two words which are synonyms, clockwise or anti-clockwise.

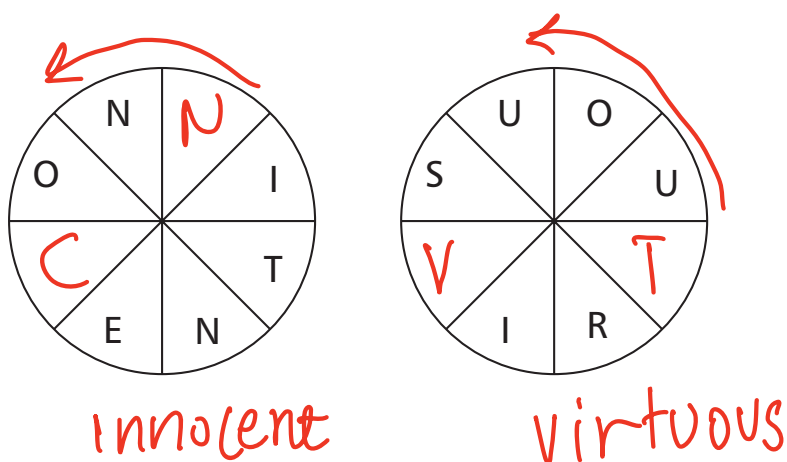

33 What is the value of x?

$$-\frac{7}{9} \div \frac{5}{27} = x \quad \frac{21}{5}$$

34 What is always associated with FAIENCE?

- a) pottery
- b) fairies
- c) zinc
- d) ingots
- e) ghosts

35 Missing tile

Which of A–F is the missing tile?

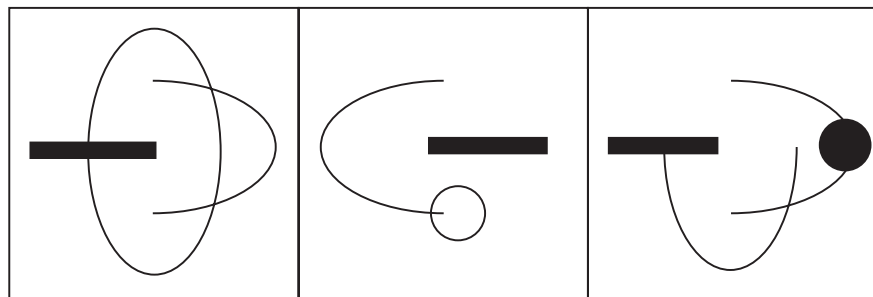
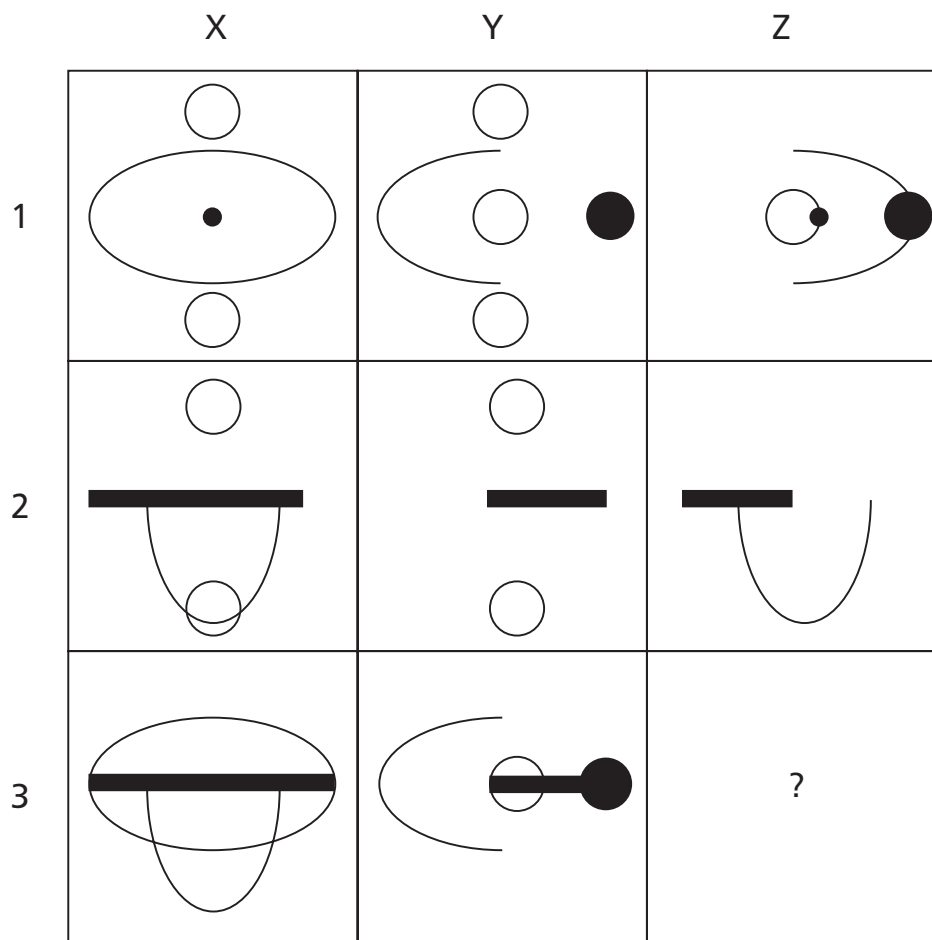

A

B

C

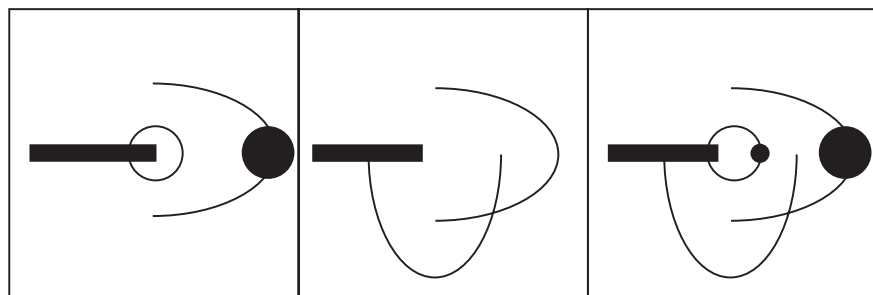

D

E

F

74 Test Your IQ

36 What is the value of x?

$$4 \times 3 - 70 \div 10 + 6 = x \quad ||$$

37 What two words mean the opposite?

CONTRADICT, CALUMNY, DISINGENUOUS,
DETESTATION, INFAMOUS, CANDID

38 Place three two-letter bits together to make a PLANT.

CH - LL - CL - OR - BR - MA - ER - IC - OV

Clover

39 Solve the one-word anagram.

NINE PUGS

Penguins

40 Odd one out

Which of these is the odd one out?

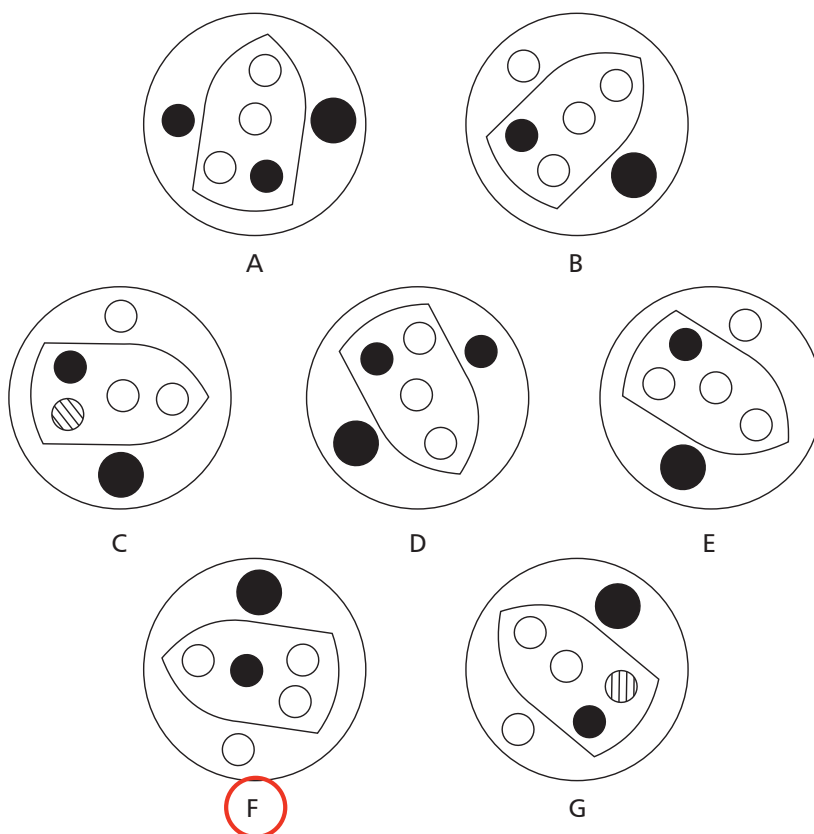

Test six

- 1 Pair a word in list A with its related adjective in list B.

List A

FLUVIAL

VERNAL

PSITTACINE

CORVID

List B

ROOK

PARROT

RIVER

SPRING

- 2 What number should replace the question mark?

7662

?

56

$$(56+1) \times 2 = 114$$

114

$$(114+2) \times 2 = 232$$

$$(3824+7) \times 2 = 7662$$

3824

232

$$(232+3) \times 2 = 470$$

1906

470

$$(470+4) \times 2 = 948$$

948

3 Comparison

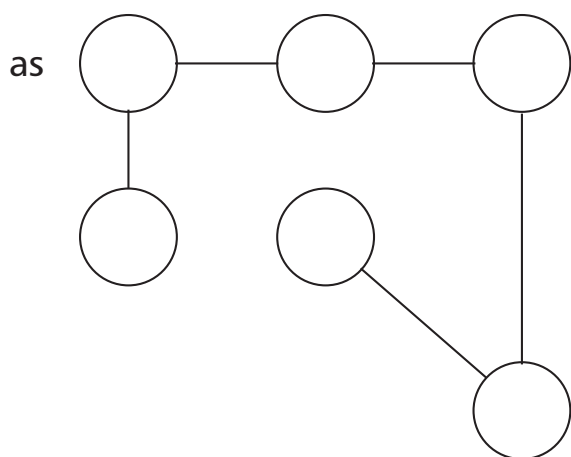
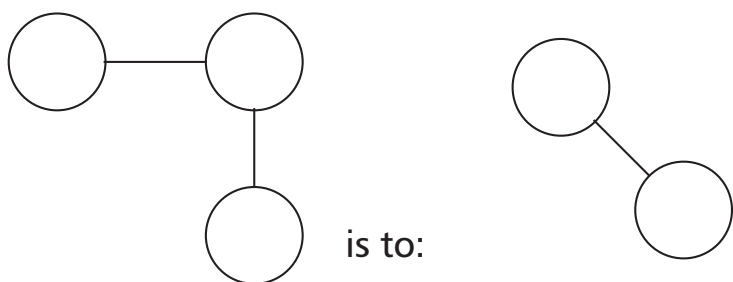

is to:

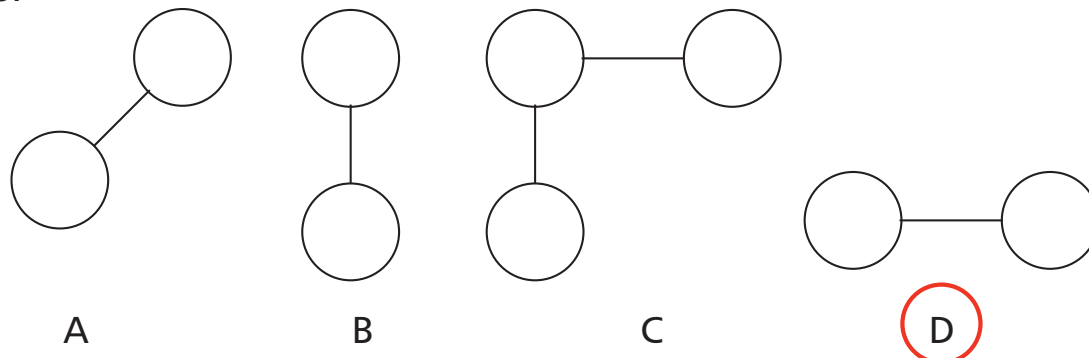

4 63 : 369

47 : 7411

86 : ? **6814**

reorder

63 : 3+6 ⇒ 9 → 369

7+4 ⇒ 11 → 7411

6+8 ⇒ 14 → 6814

5 Add one letter, not necessarily the same letter, to each word at the front, end or middle to find two words that are synonyms.

RUSH, BEAK

CRUSH Break

- 6 Start at one of the corner squares and spiral clockwise round the perimeter to spell out a nine-letter word and finish at the centre square. You must provide the missing letters.

Caretaker

R	E	t
A	R	a
C	E	K

- 7 Which number comes next in the following sequence?

53472, 2435, 342, ? 23

- 8 Which of the following is not an anagram of an animal?

BRISK PONG

PUNCH KIM

RED OPAL

• MOMS HOUR

FAB FOUL

- 9 What letter completes this sequence?

A B D O P Q ? R

الحروف التي فيها صوت مخرج من الف

- 10 Which word in brackets means the same as the word in capitals?

PROGENY (skill, lineage, movement, progress, vocation)

78 Test Your IQ

11 Which three words can be inserted so that the phrase is palindromic, ie it reads the same backwards and forwards?

A DOG! A *Panic.in* A PAGODA

12 How many lines appear below?

11

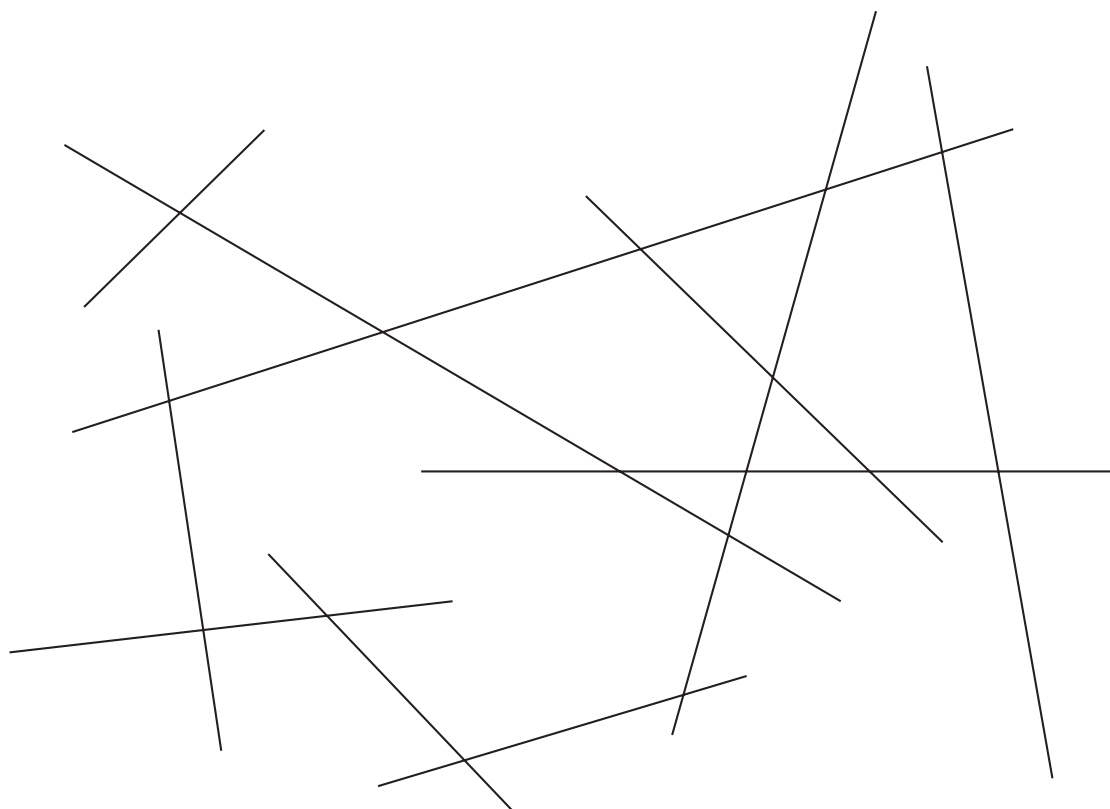

13 Sequence

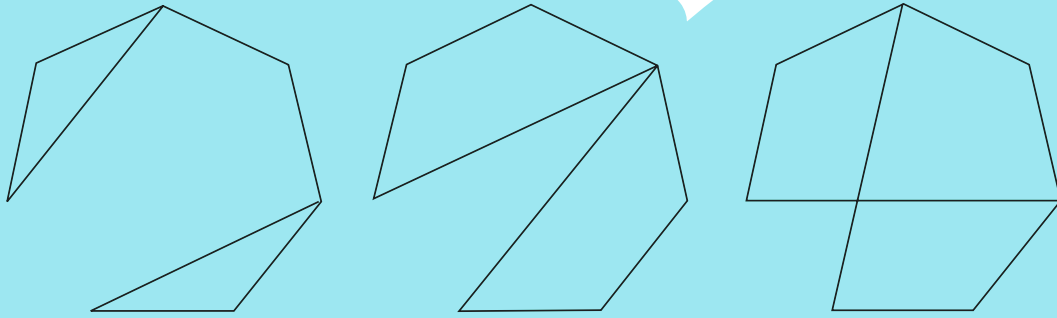

What comes next in the above sequence?

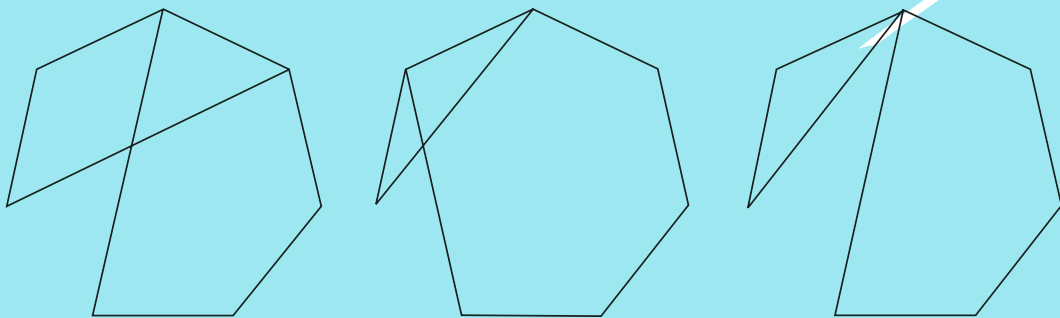

A

B

C

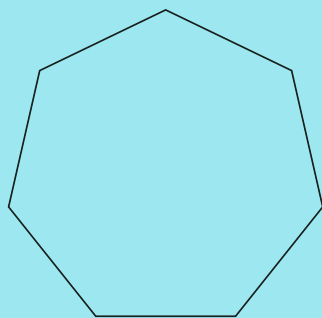

D

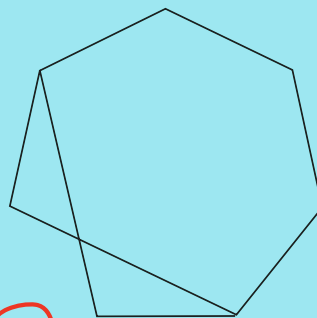

E

14 Below are eight CARING words. Take one letter from each of the eight words in turn to spell out a ninth CARING word.

Clue: dependable

FERVENT, CORDIAL, DOTING, DEVOTED, ATTACHED,
FOND, AMOROUS, LOVING

Faithful

18 Find the phrase that has been hidden by removing the initial letter of each word, then removing the space between them.

NHEEVEL On the level

19 What number should replace the question mark?

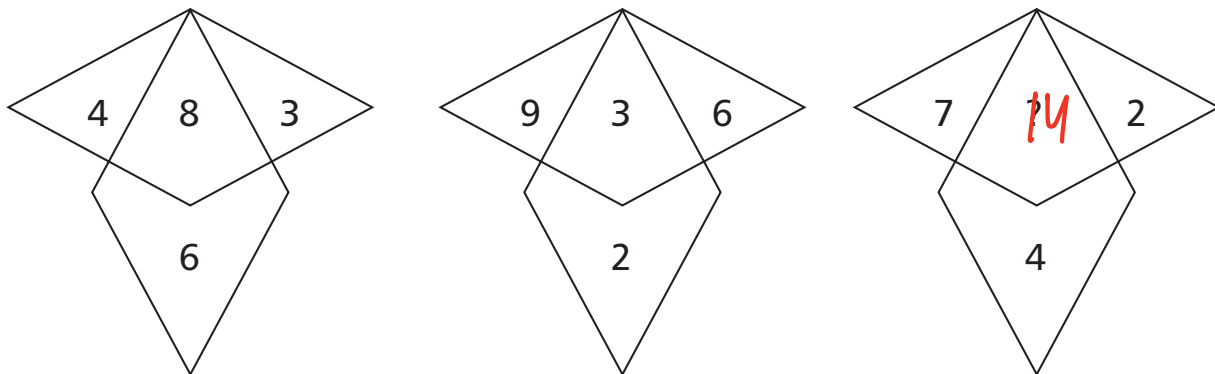

- 20 PERIGEE : APOGEE
 PERIHELION : a) azimuth
 b) elliptic
 c) orrery
 d) nadir
 e) aphelion

$$\frac{7 \times 4}{2} = 14$$

21 Fill in the blanks, clockwise or anti-clockwise, to complete the word.

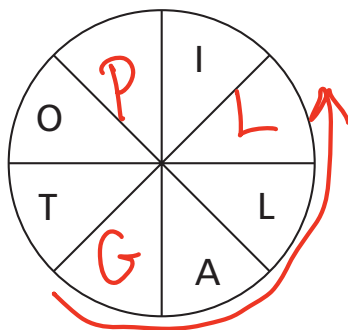

Gallipot

82 Test Your IQ

22 Which two words mean the same?

VERBOSE, MERCIFUL, CONCORDANT, MOMENTOUS,
MENIAL, PROLIX

23 Place three two-letter bits together to make a vegetable.

RA – EN – LE – RI – CI – DI – CE – VE – SH

Endive

24 What is a FERRULE?

- a) a metal band
- b) a circus wheel
- c) a window
- d) a funeral
- e) rusty

25 Symbols

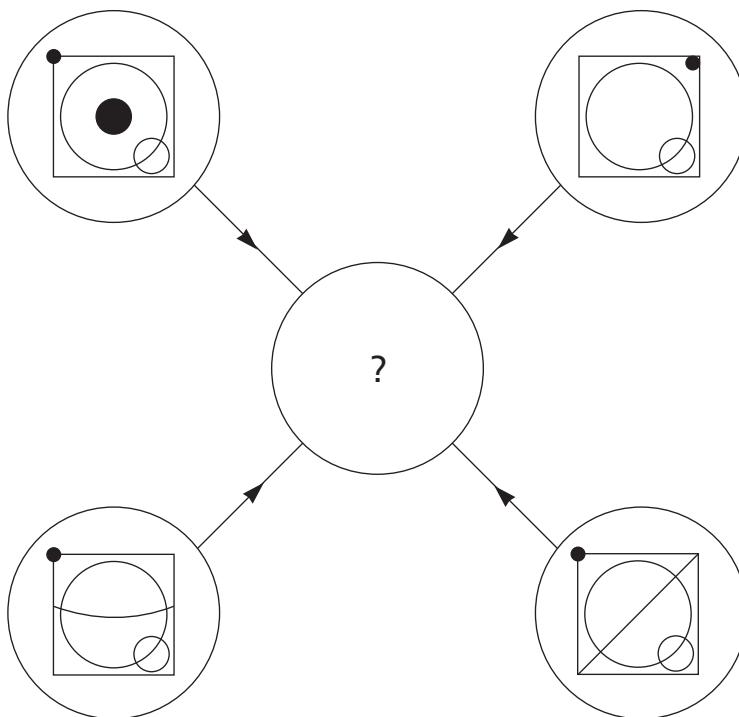

Each line and symbol that appears in the four outer circles, above, is transferred to the centre circle according to these rules:

if a line or symbol occurs in the outer circles:

- once: it is transferred
- twice: it is possibly transferred
- 3 times: it is transferred
- 4 times: it is not transferred.

Which of the circles A, B, C, D or E, shown below, should appear at the centre of the diagram, above?

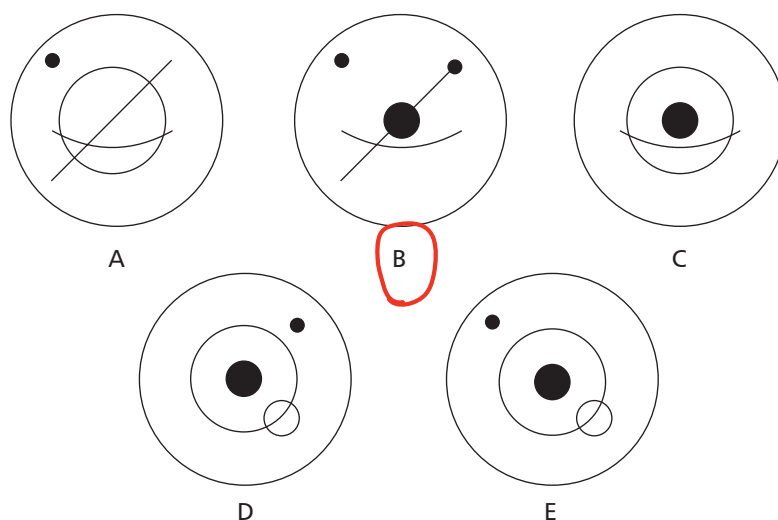

84 Test Your IQ

26 Place two three-letter bits together to make a dog.

TER – ZOE – BEA – SET – IER – GLI – BAS – BOR

Basset

27 What number should replace the question mark?

6	4	4	22
4	3	3	13
1	5	4	21
2	6	7	? 44

$2 + (6 \times 7) \rightarrow$

28 What number should replace the question mark?

$(4 \times 16) - (4 \times 16) = 12$

4	19
12	
4	16

6	7
30	
3	4

$(6 \times 7) - (3 \times 4) = 30$

29 What is the name given to a group of KITTENS?

- a) clutch
- b) labour
- c) swarm
- d) kindle**
- e) sounder

30 Grid

Each of the nine squares in the grid marked 1A to 3C should incorporate all the lines and symbols that are shown in the squares of the same letter and number immediately above and to the left. For example, 2B should incorporate all the lines and symbols that are in 2 and B.

One of the squares is incorrect. Which one is it?

	A	B	C
1	1A	1B	1C
2	2A	2B	2C
3	3A	3B	3C

31 What is always associated with GENOA?

- a) a bustle
- b) haberdashery
- c) an eye glass
- d) a sail**
- e) a short cloak

32 Solve the one-word anagram.

IRON COPS

Scorpion

33 What number should replace the question mark?

10, 1, 9, 6, 8, 11, 7, ? 16

(Handwritten annotations: blue arcs connect 10 to 9 (+5), 9 to 6 (-3), 6 to 8 (+2), 8 to 11 (+3), 11 to 7 (-4). Below the sequence are three minus signs: - | - | - |)

34 Fill in the blanks, clockwise or anti-clockwise, to form two words that are synonyms.

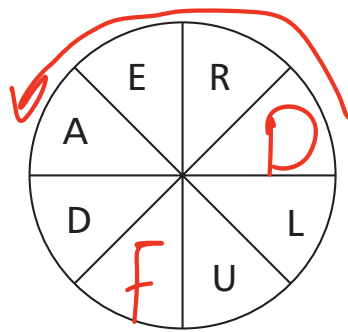

Dreadful

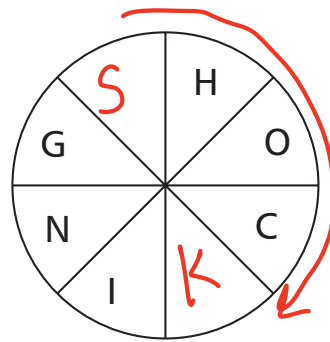

Shocking

35 Circles

Which of A, B, C, D or E fits into the blank circle to carry on a logical sequence?

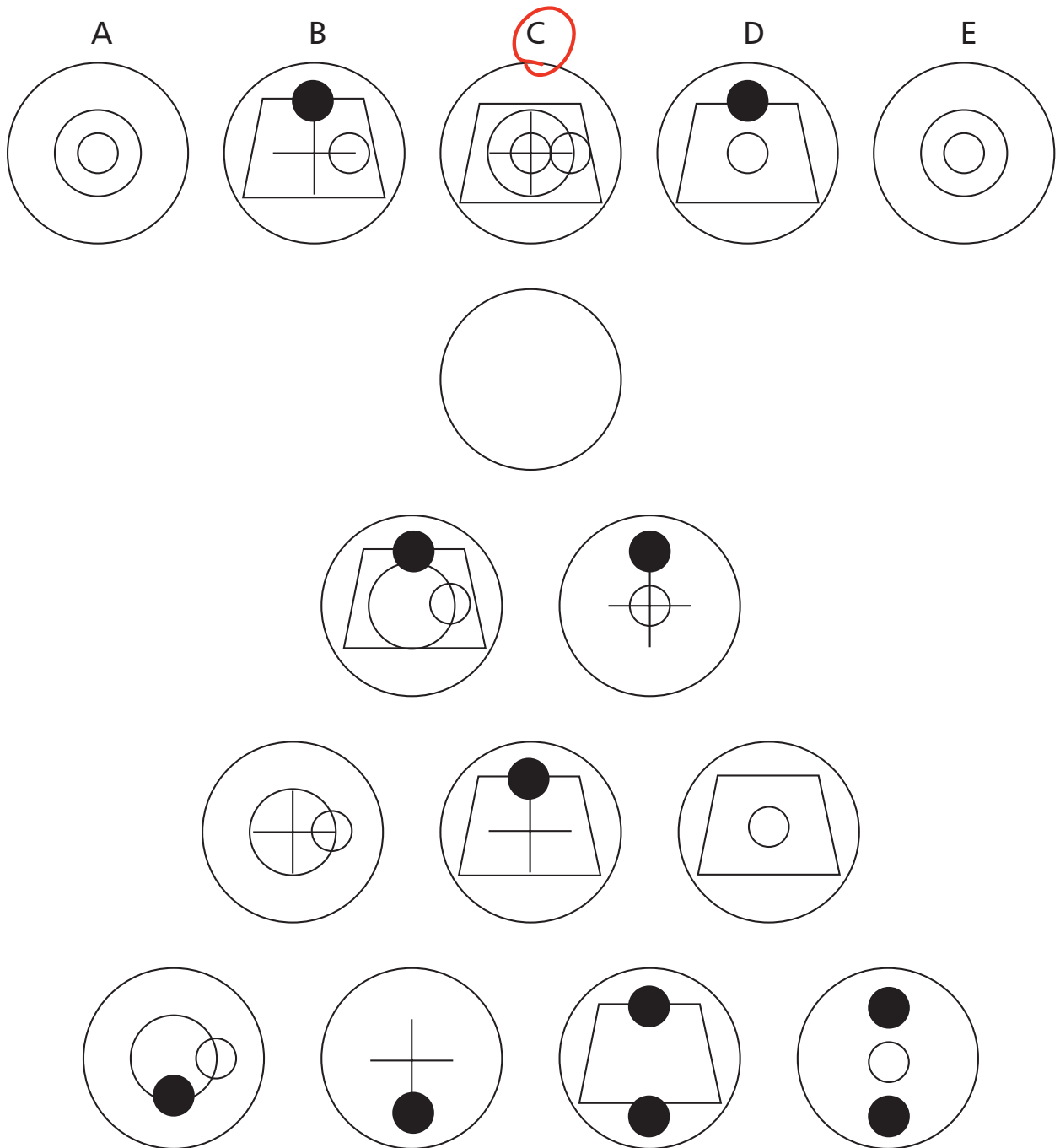

88 Test Your IQ

36 What number should replace the question mark?

4		12
	64	
8		4

3		9
	216	
3		12

20		9
	?	
6		2

120

$$(20 \times 2) \times (9 - 6)$$

$$= 120$$

37 Which one of these is not a flower?

ALEZAA

SUCROC

VILSAA

TEVOIL

TRYLUS

38 Insert a word that means the same as the words outside the brackets.

STINGY (Mean) AVERAGE

39 Solve:

$$-6 + (7 \times 8) - 3 \div 2 + 19 = x \quad 67.5$$

40 Comparison

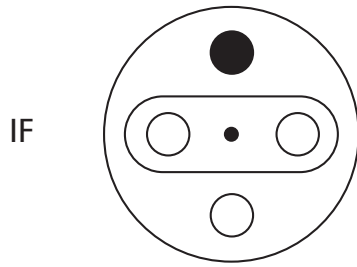

IS TO:

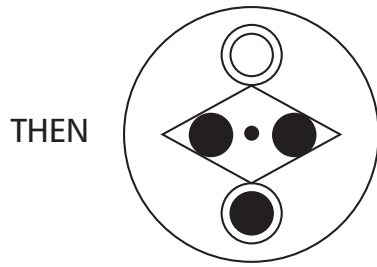
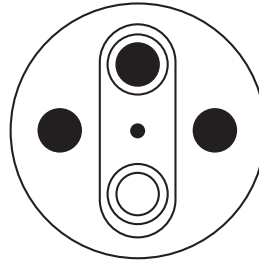

IS TO:

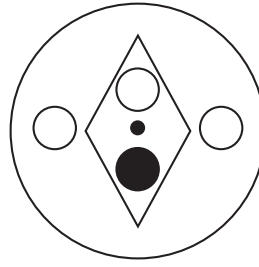

A

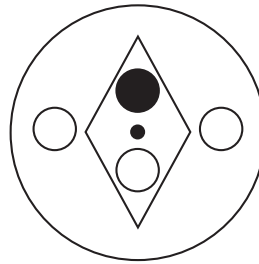

B

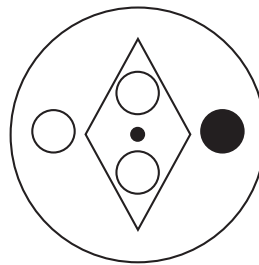

C

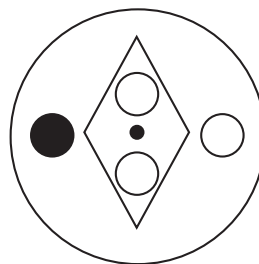

D

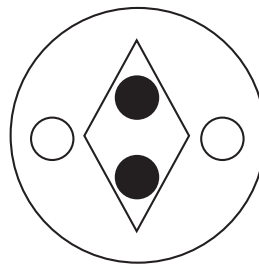

E

Test seven

1 Sequence



What comes next in the above sequence?

- A
- B
- C
- D
- E

2 Which other sport-related phrase can be placed in the right-hand column reading downwards in order to complete the six three-letter words reading across? The phrase you are looking for has two words (8, 4).

A		S
C	U	T
T	E	a
I		r
O	A	+
N		i
R	A	n
E		g
P	E	p
L		o
A	S	s
Y		T

Starting Post

3 Which word continues this sequence?

COUNTERFEIT, FLOUNDERING, ENCOUNTERED,
SUBJOINDERS

Is it: viscountess, dumbfounded or preannounce?

4 What number should replace the question mark?

Clue: think laterally

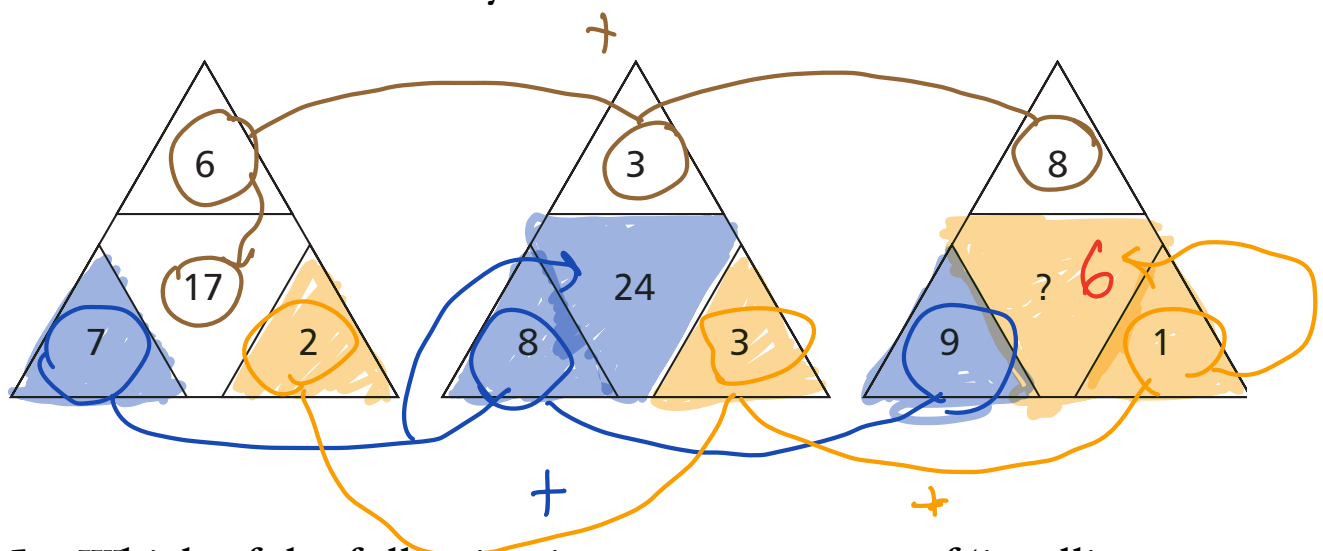

5 Which of the following is not an anagram of 'intelligence test'?

TESTING ELECT LINE

TESTING CLIENTELE

TIES GENTLE CLIENT

LET TESTING CLIENT *having Extra T*

GET LITTLE INCENSE

ELICIT GENTLE NETS

92 Test Your IQ

6 Which of the numbers, from 1 to 121, appears in the grid twice, and which number is missing?

25 57

61	102	30	115	80	32	73	110	36	89	18
90	35	119	74	117	83	48	26	11	95	50
49	113	19	7	101	41	15	3	94	44	13
85	14	25	120	53	109	43	23	29	81	6
37	99	98	2	108	78	62	34	56	69	40
60	10	24	93	72	22	107	51	1	118	28
33	75	92	47	104	86	114	17	76	105	21
82	4	27	116	52	12	84	71	111	63	8
91	59	16	68	39	66	96	25	100	70	38
20	42	79	9	55	64	77	5	54	88	45
67	103	46	97	31	87	106	58	121	65	112

7 Which word in brackets is opposite in meaning to the word in capitals?

GRUESOME (enjoyable, appealing, wholesome, young, virtuous)

8 What number should replace the question mark?

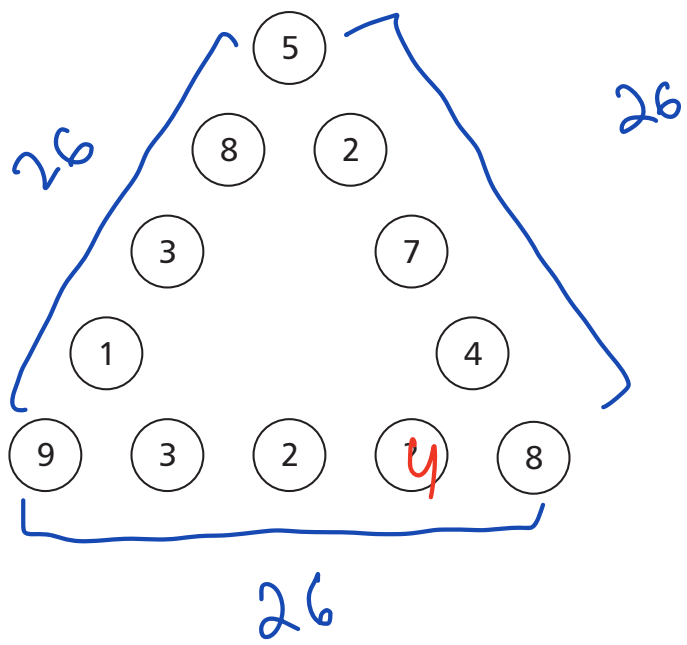

9 Solve the clues to find four six-letter words. The same three letters are represented by XYZ in each word.

- Cattle* ← XYZ... Clue: bovine animals
- Scathe* ← .XYZ.. Clue: attack with severe criticism
- Locate* ← ..XYZ. Clue: find
- Muscat* ← ...XYZ Clue: type of grape

Cat

10 Sequence

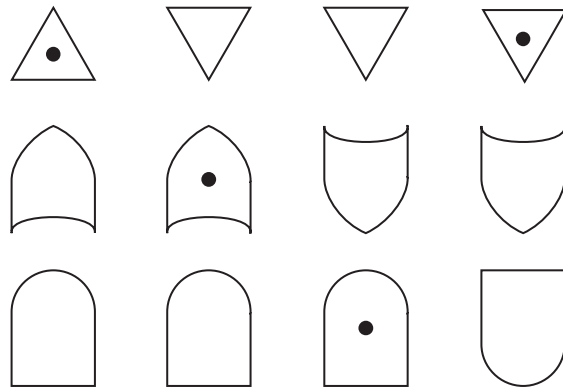

What comes next in the above sequence?

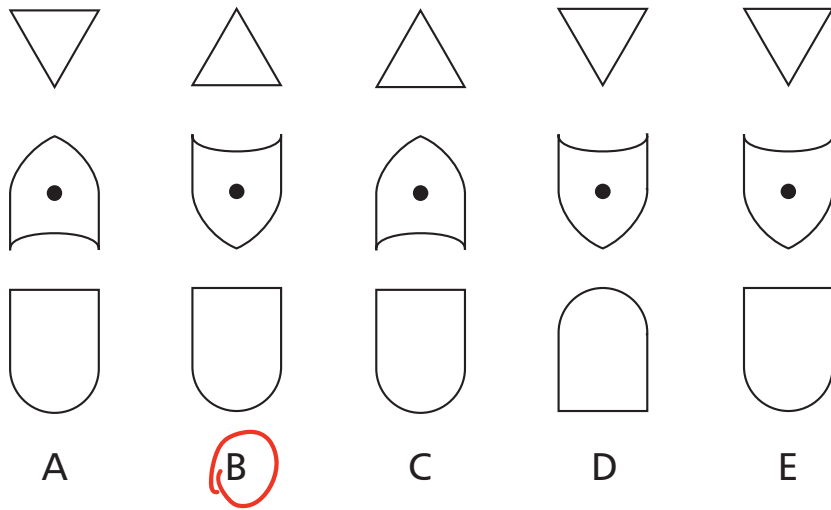

11 Change CAPRICORN to LIBRA. Each word repeats several letters from the word above it as indicated by *.

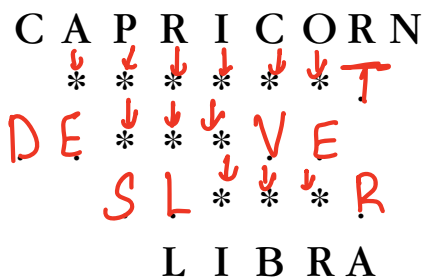

94 Test Your IQ

12 Find the starting point and follow the correct route from circle to circle to spell out a phrase (4, 2, 1, 3)

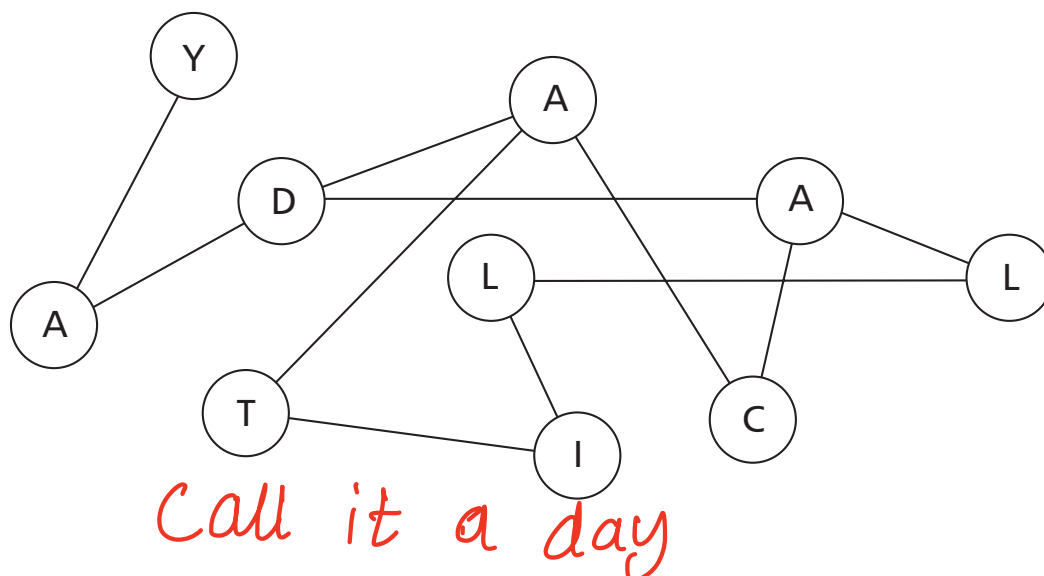

13 Insert a three-letter word that will complete the first word and start the second.

SEA (*son*) NET . *Season sonnet*

14 A number of antonyms of the keyword are shown. Take one letter from each of the antonyms, in order, to spell out another antonym of the keyword.

KEYWORD : OMNIPOTENT

ANTONYMS: INFERIOR, IMPOTENT, POWERLESS, VULNERABLE, FRAIL, INCAPABLE

Feeble

15 SUNDAY } +1
MONDAY } +2
WEDNESDAY } +3
SATURDAY } +4
WEDNESDAY } +4
 } +3

Which day comes next?

Monday

16 Sequence

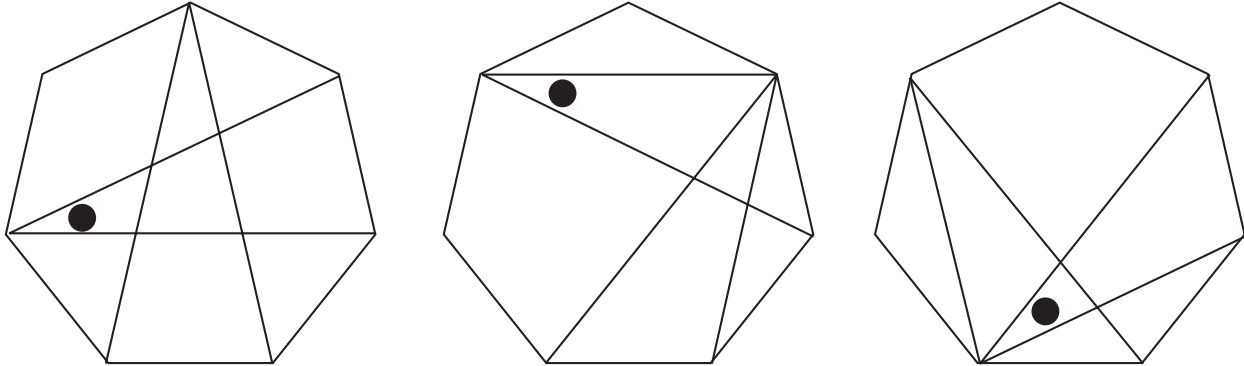

What comes next in the above sequence?

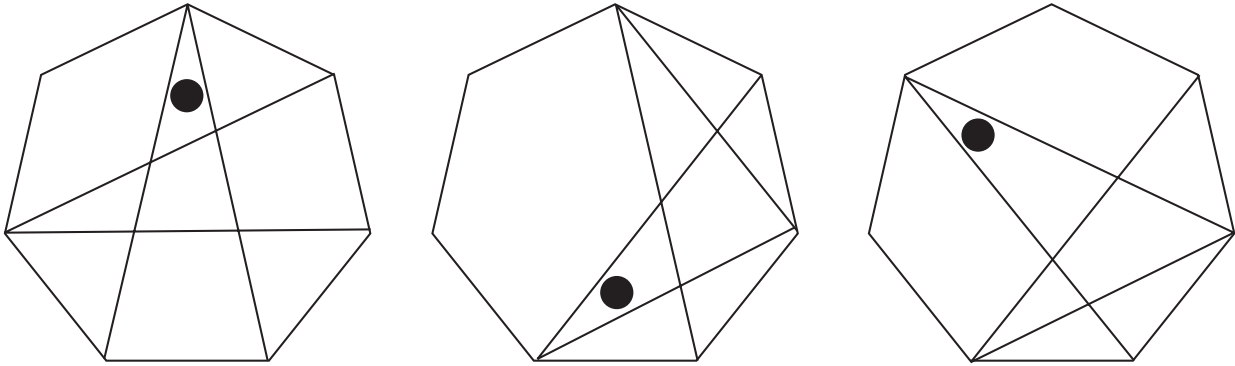

A

B

C

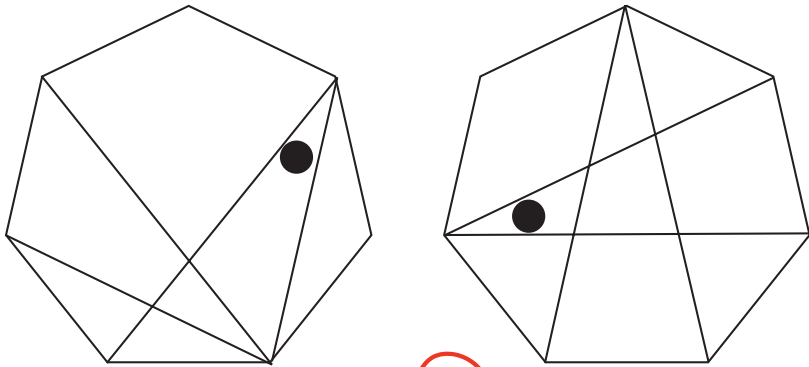

D

E

96 Test Your IQ

17 Visit each square once only and finish at the centre square to collect the treasure. 1E means one square East, 2W means two squares West.

8 5 3
6 T 1
4 2 7
No idea!

1 E 1 S	1 S 1 W	2 W 2 S
2 E 1 S	T	1 S 1 W
1 E 2 N	2 N 1 E	2 W 2 N

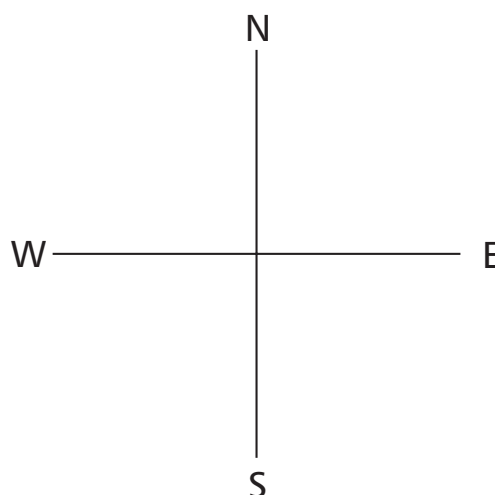

18 Solve each anagram to find two phrases that are spelt differently but sound alike, as in 'a name', 'an aim'.

WOKEN CANON INTO NOON

Known ocean, No notation

19 The grid contains 25 different letters of the alphabet. What is the longest word that can be found by starting anywhere and working from square to square horizontally, vertically and diagonally, and not repeating a letter?

Clue: Significantly

Q	U	J	X	F
W	N	O	E	K
S	V	D	C	R
G	I	Y	A	H
P	M	L	B	T

Considerably

20 What do the following have in common?

TOTAL ECLIPSE
 A PIG IN A POKE
 WHITE ADMIRALS

they contain
 Name of drinks

21 Fill in the blanks, clockwise or anti-clockwise, to complete the word.

for-saken

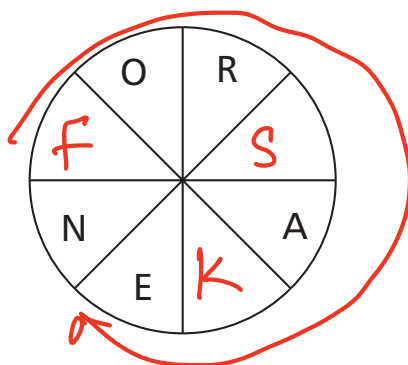

22 Which word means the same as ESOTERIC?

- a) pristine
- b) misshapen
- c) gibbous
- d) secret**

23 What number should replace the question mark?

3		6
	42	
7		2

7		4
	80	
4		2

14		2
	?	
8		11

48

24 Solve the one-word anagram.

IT CLAW'D

Wild Cat

$$\begin{array}{r}
 (8 \times 2) \\
 \times (14 - 11) \\
 \hline
 48
 \end{array}$$

25 Circles

Which of A, B, C, D or E fits into the blank circle to carry on a logical sequence?

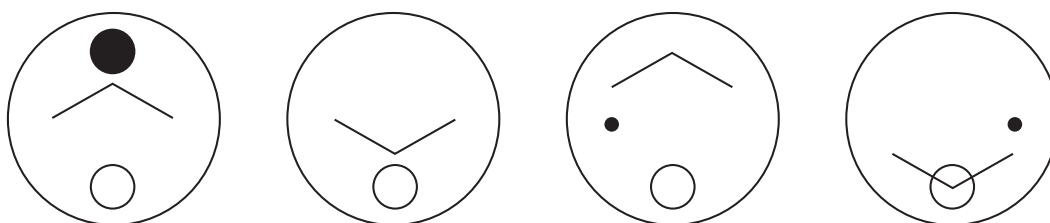
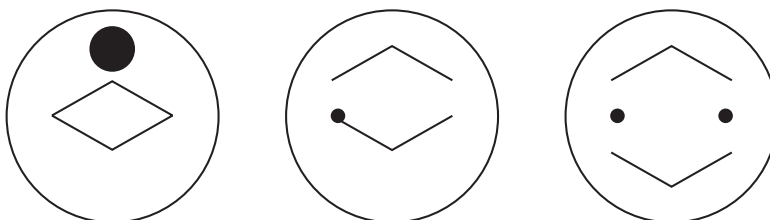
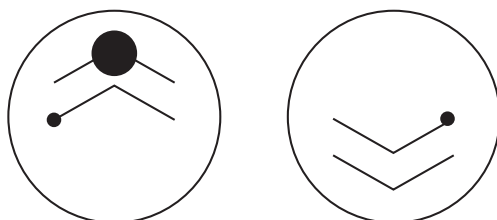
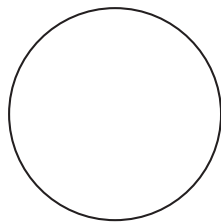
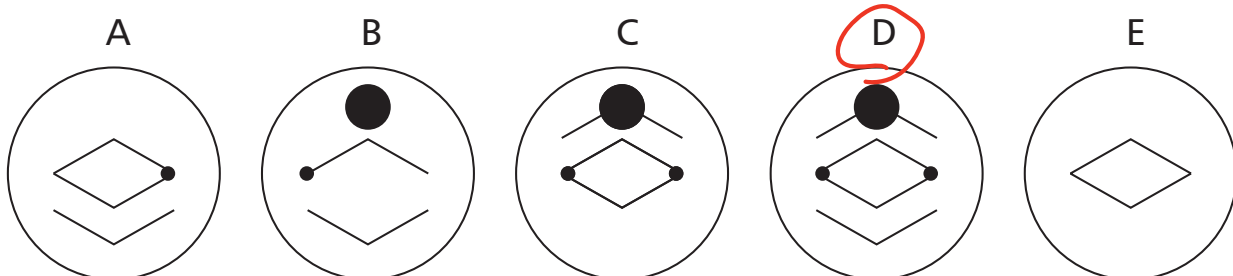

26 What number should replace the × ?

$$\frac{64}{8} = 8 - 2 = 6$$

64	8	2	6
21	7	1	2
30	5	1	5
24	4	2	X ⁴

$$\frac{24}{4} = 6 - 2$$

27 What is a GIGOT?

- a) a dancer
- b) a leg of mutton
- c) a rogue
- d) a measure
- e) a ravine

28 Place two three-letter bits together to make a FISH.

KIP – ICY – PLA – MIN – PEN – NOW – HAD – DOK

Minnow

29 Which two words mean the opposite?

LICENTIOUS, CARP, FITFUL, CIRCUMSPECTION,
APPROVE, DEMEANOUR

30 Symbols

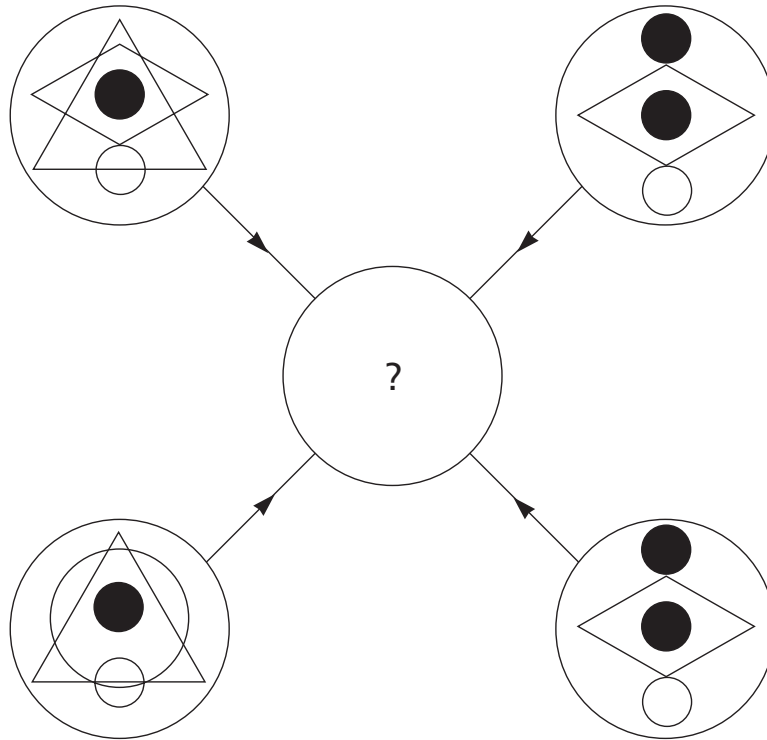

Each line and symbol that appears in the four outer circles, above, is transferred to the centre circle according to these rules:

if a line or symbol occurs in the outer circles:

- once: it is transferred
- twice: it is possibly transferred
- 3 times: it is transferred
- 4 times: it is not transferred.

Which of the circles A, B, C, D or E, shown below, should appear at the centre of the diagram, above?

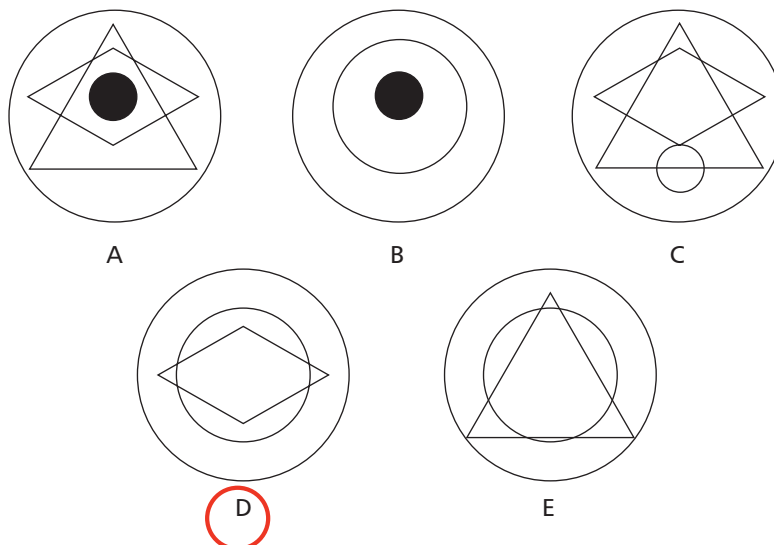

31 What is always associated with HASLET?

- a) food
- b) drink
- c) a machine
- d) a necklace
- e) a farm appliance

32 What number is to replace the question mark?

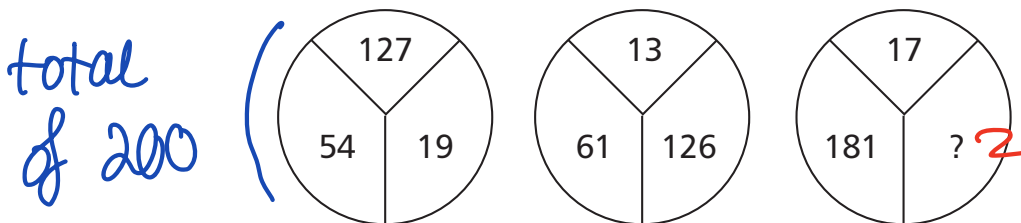

33 Fill in the blanks, clockwise or anti-clockwise, to form two words that are synonyms.

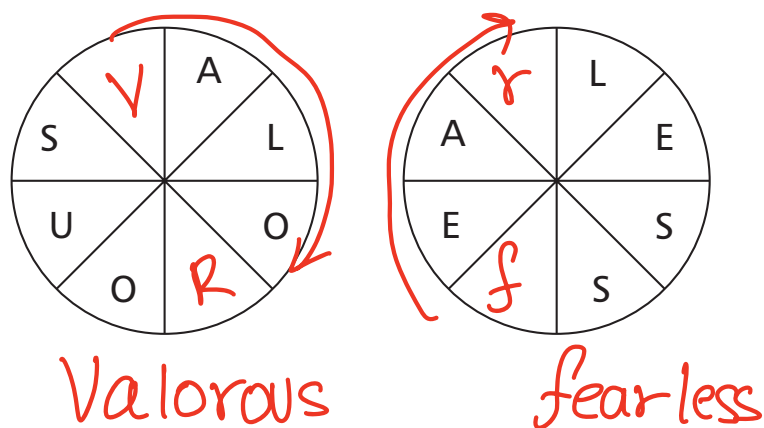

34 Make a six-letter word using only these four letters.

LY
GO

Oology

35 Grid

Each of the nine squares in the grid marked 1A to 3C should incorporate all the lines and symbols that are shown in the squares of the same letter and number immediately above and to the left. For example, 2B should incorporate all the lines and symbols that are in 2 and B.

One of the squares is incorrect. Which one is it?

	A	B	C
1	1A	1B	1C
2	2A	2B	2C
3	3A	3B	3C

36 Insert a word that means the same as the words outside the brackets.

NOBLE (*Man*) KIND

37 What number should replace the question mark?

7, 14, 8, 10, 9, 6, 10, ? *2*

38 What is the name given to a group of LARKS?

- a) exaltation
- b) badelynge
- c) flock
- d) pitying
- e) run

39 Which one of these is not a musical instrument?

- NILOIV
- MATBAN
- THIZRE
- LAMYCB
- DDIEFL

40 Hexagon

Which hexagon, A, B, C, D or E, fits the missing space?

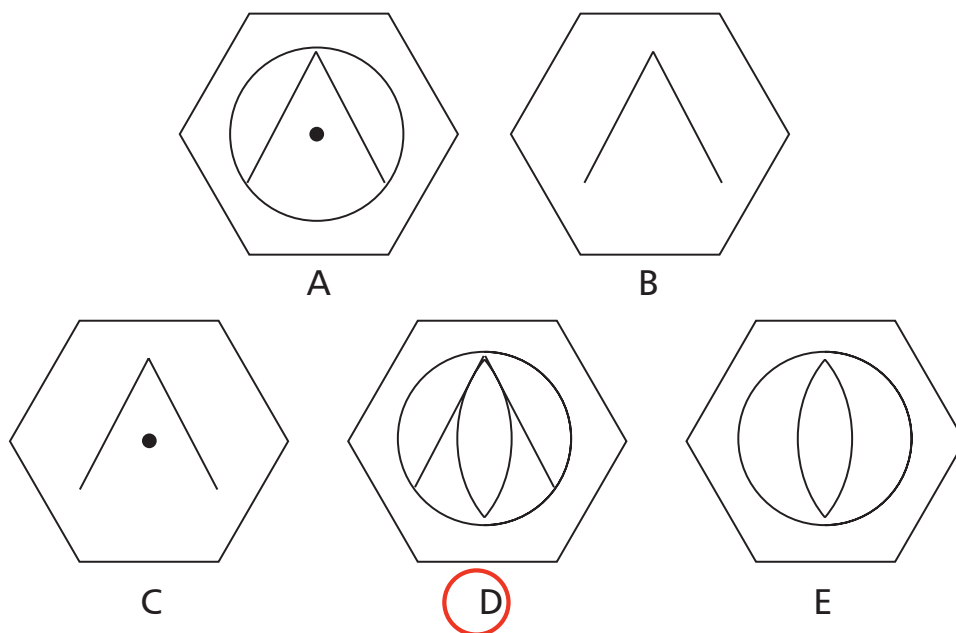
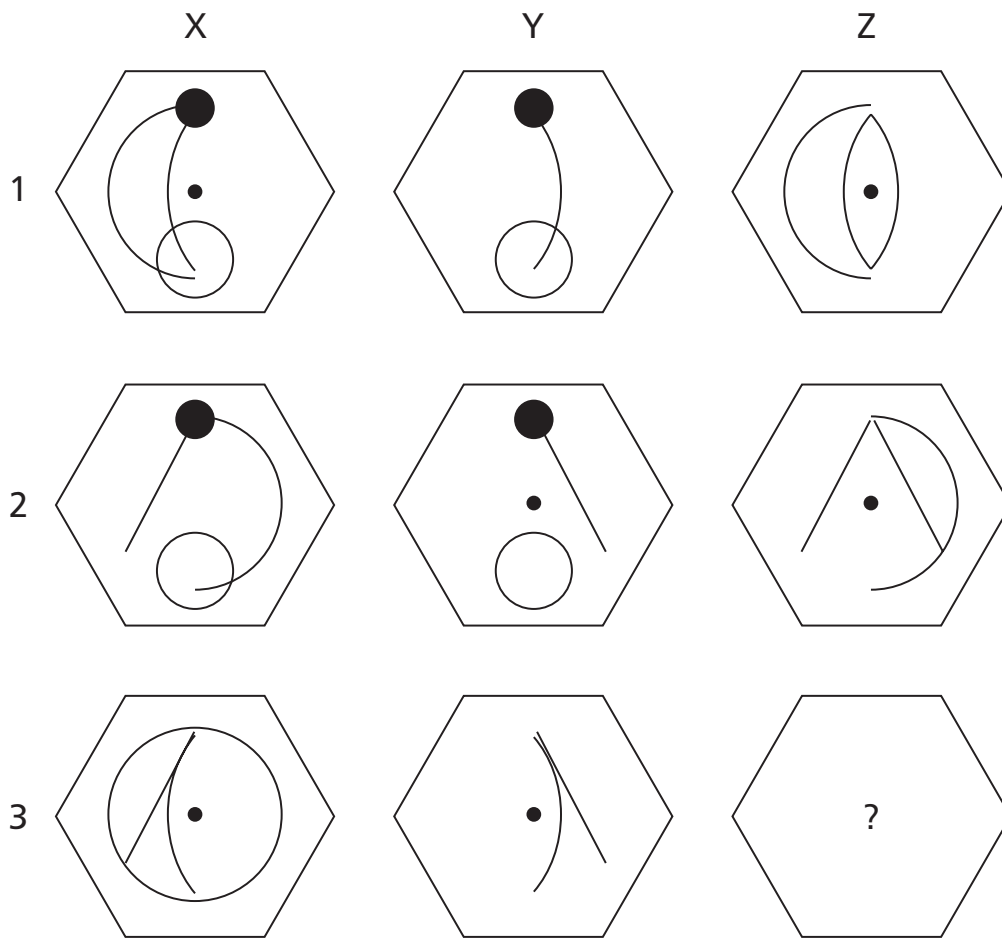

Test ten

1 Which number is the odd one out?

$$4236 = \frac{46}{2} \Rightarrow (23)$$

$$174 = \frac{14}{2} \Rightarrow (7)$$

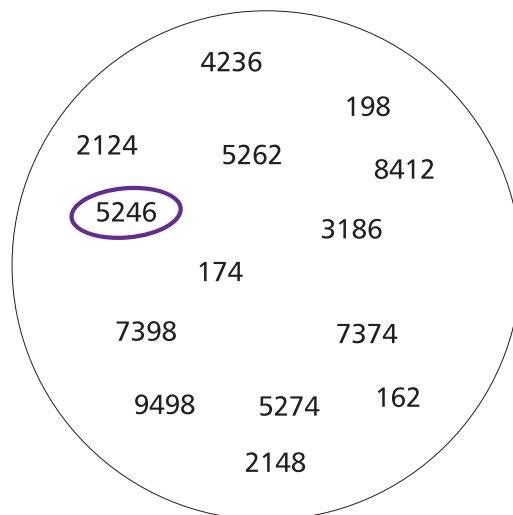

2 Spiral clockwise to find a 10-letter word. Only alternate letters are shown.

Clue: outwit

Circumvent

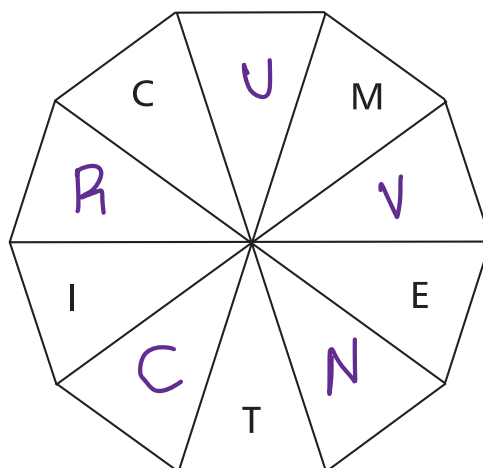

3 Comparison

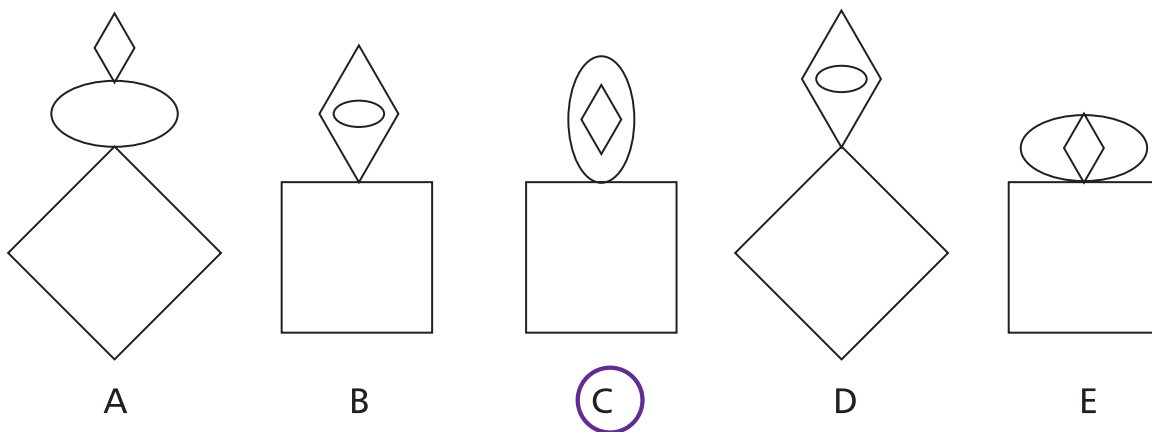
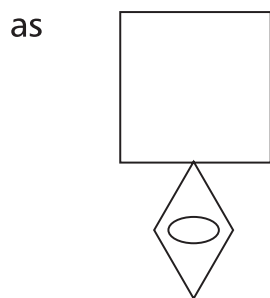
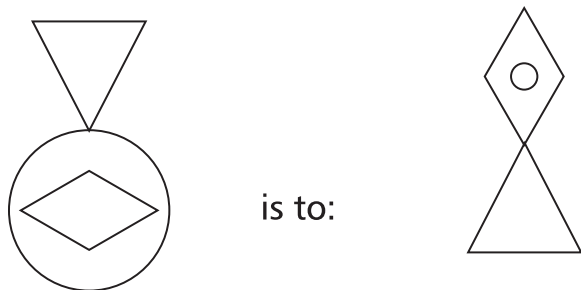

4 Each square contains the letters of a nine-letter word. The two words are synonyms, and the overlapping letters T and A appear in each word. Can you unscramble them?

*Eradicate
eliminate*

D	E	R		
E	C	T	M	E
I	A	A	L	I
		N	E	I

- 7 If presented with the words MAR, AM and FAR and asked to find the shortest word that contained all the letters from which these words could be produced, you should come up with the word FARM.

Here is a further list of words:

ANGRY, LYNCH, MAGIC

What is the shortest English word from which all these words can be produced?

Charmingly

Clue: captivatingly

- 8 Which box of numbers (A, B, C or D) should replace the box of question marks?

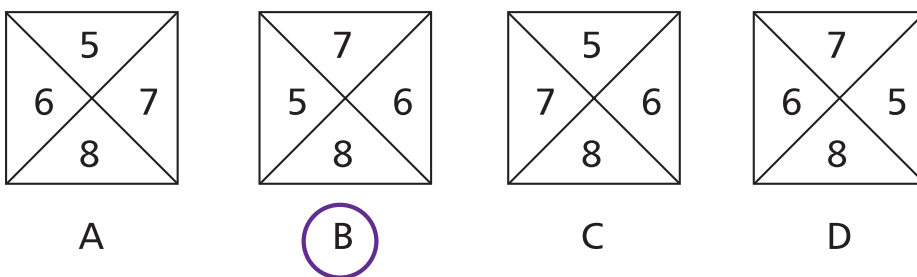
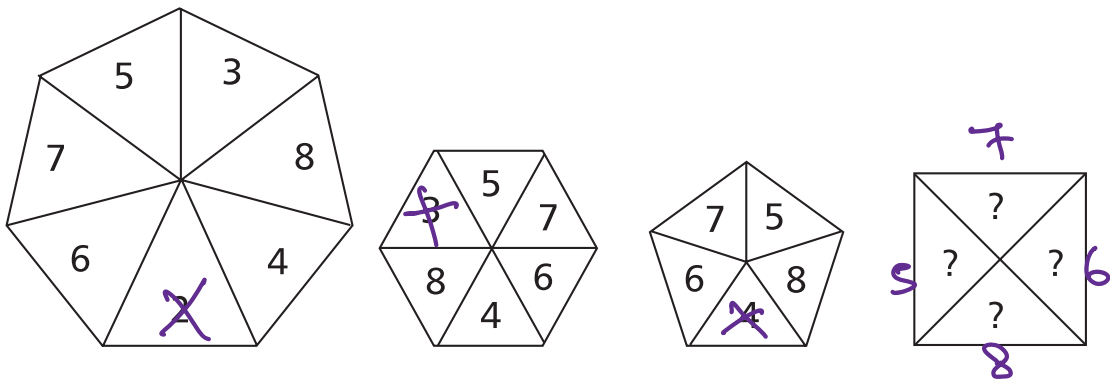

9 Boxes

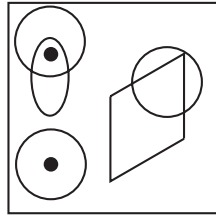

To which of the boxes below can a dot be added so that it meets the same conditions as in the box above?

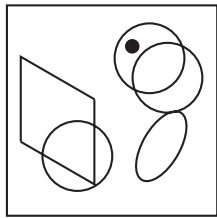

A

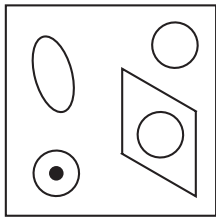

B

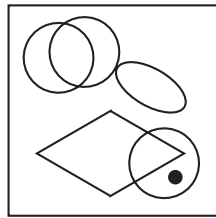

C

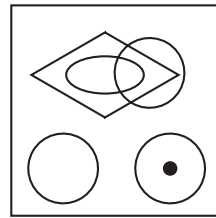

D

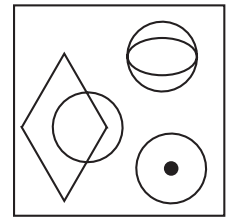

E

10 What number should replace the question mark?

المجموع 23

1	
2	8
4	9

2	
1	5
3	4

3	
?	7
8	8

2

11 Read clockwise to find two words, one in each circle, that are antonyms. You must provide the missing letters.

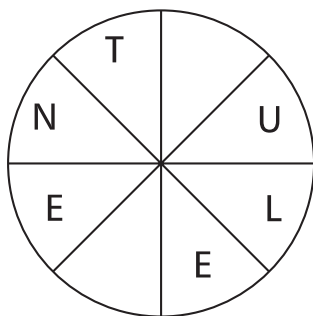

Eventful

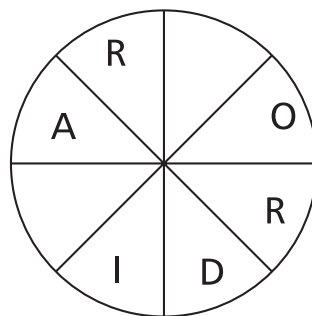

ordinary

140 Test Your IQ

$$\begin{array}{r} 1017 \\ 117 \\ \hline 99 \\ \hline 18 \end{array}$$

12 What number comes next in this sequence?

100, 99, 117, 108, ? 117

-1 $+18$ -9 $+9$
 \downarrow \downarrow \downarrow \downarrow
 99 $(1+1+7)$ $(1+8)$

$$\begin{array}{r} 017 \\ 117 \\ \hline 108 \\ \hline 009 \end{array}$$

13 Comparison



is to:

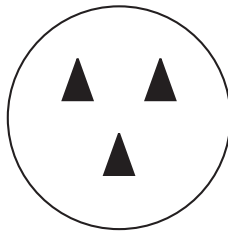

as



is to:



A



B



C



D



E

- 14 Read along the connecting lines from circle to circle to spell out a well-known phrase, especially at a certain time of the year (6, 4).

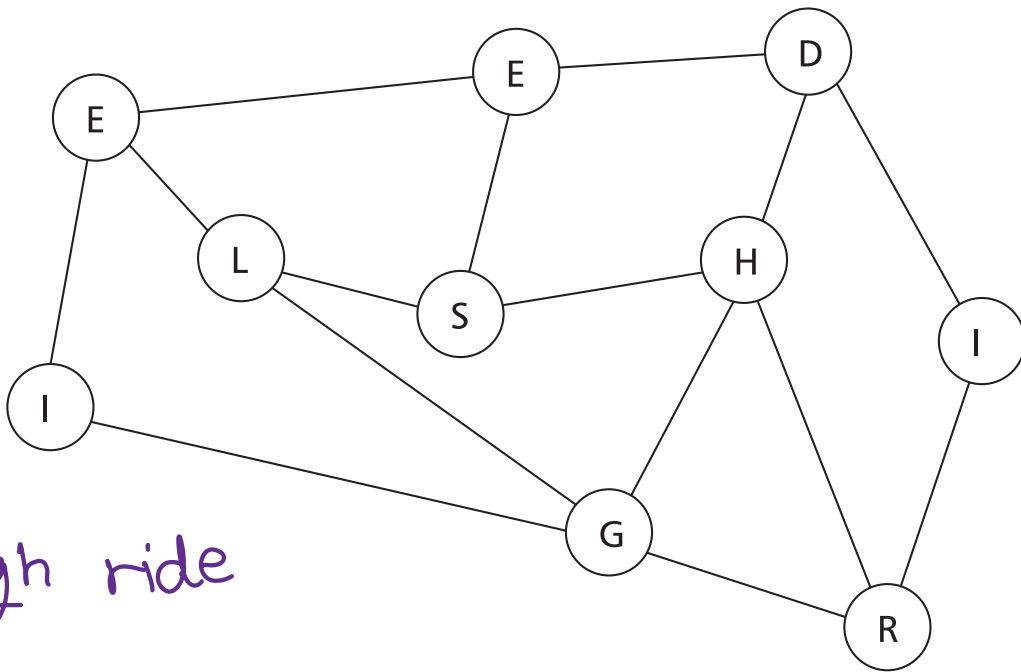

Sleigh ride

- 15 What word is both a weaving machine and means 'to menace'?

Loom

- 16 CRUSH VIOLA is an anagram of which 10-letter word?

Chivalrous

17 Sequence

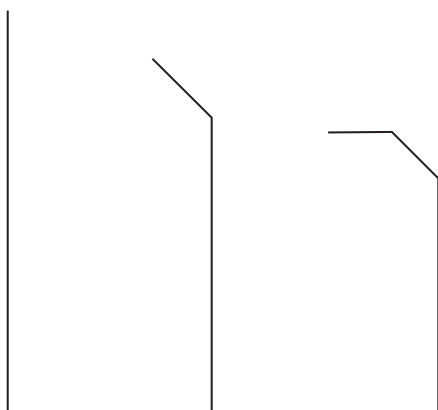

Which option below continues the above sequence?

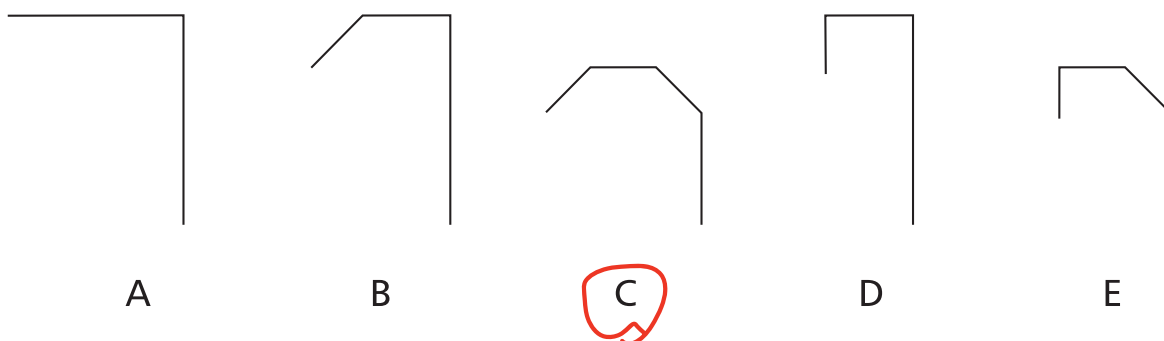

18 What number comes next in this sequence?

1, 1.5, 2.5, 4, ?

Handwritten annotations: 0.5 (between 1 and 1.5), 1.5 (between 1.5 and 2.5), 2 (between 2.5 and 4), and 6 (next to the question mark).

19 Only one set of letters below can be arranged into a five-letter word. Can you find the word?

MUCHO

WINFO

ALPIC

DEPNU

BRENU

20 What word replaces the question marks in order to form seven five-letter words sandwiched between the letters on the right and the left?

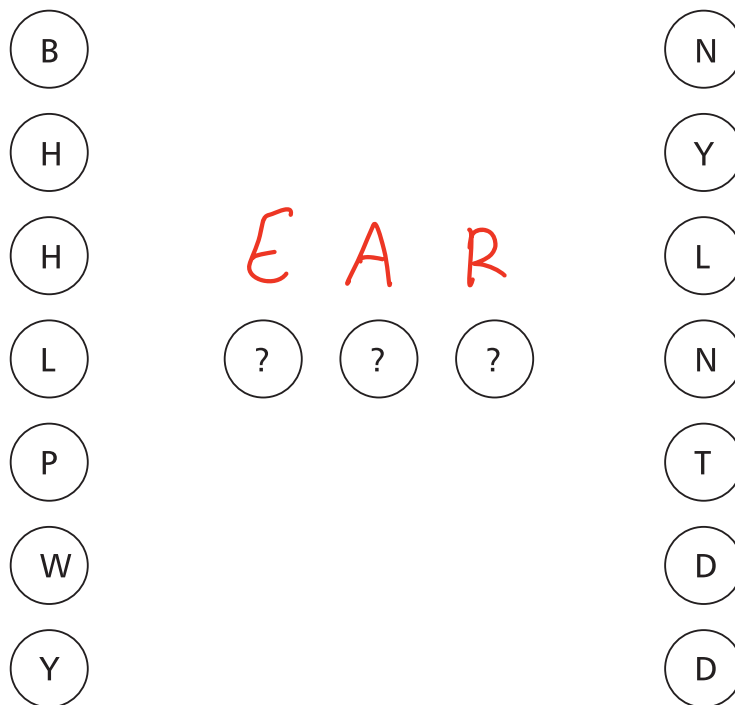

21 Fill in the blanks, clockwise and anti-clockwise, to complete the word.

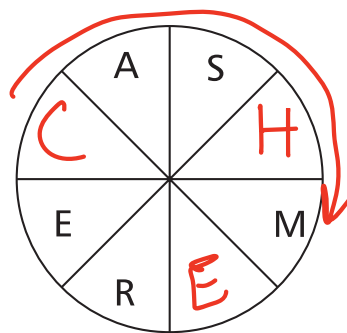

Cashmere

22 What is always associated with NUX VOMICA?

- a) gunpowder
- b) an organ
- c) strychnine
- d) smelling salts
- e) hymns

23 Which is the odd one out?

- a) ballista
- b) ventage**
- c) arquebus
- d) claymore
- e) bazooka

24 What is ZAPATEADO?

- a) a moustache
- b) a dance**
- c) a drumming noise
- d) a dish
- e) a flower

25 Odd one out

Which is the odd one out?

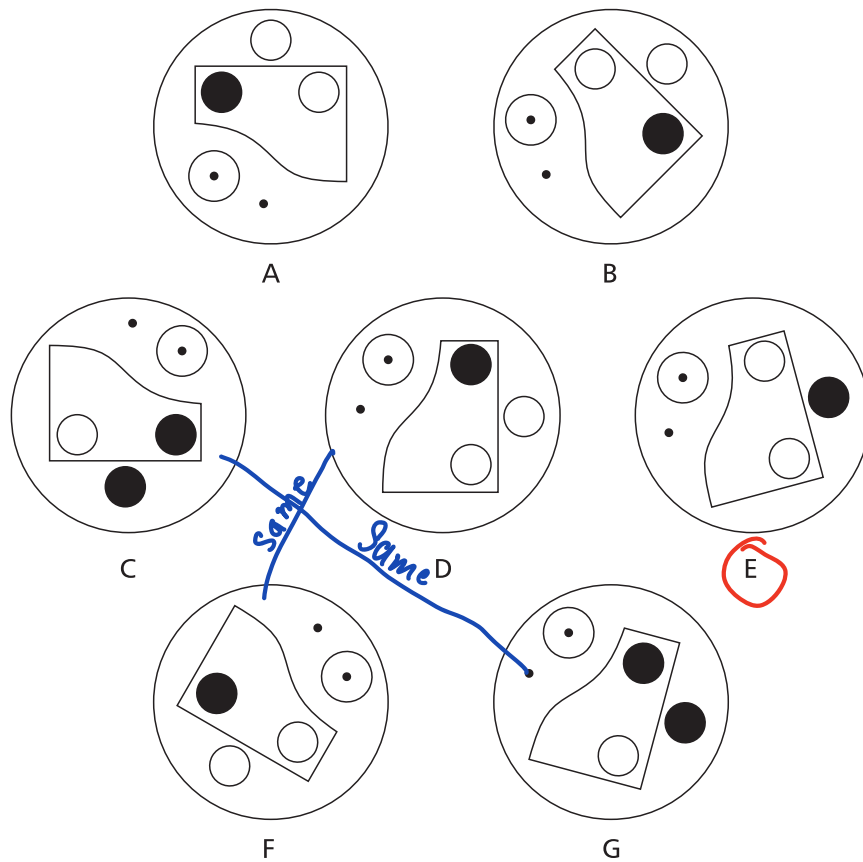

26 What is the meaning of NUBILE?

- a) lithe
- b) charismatic
- c) marriageable
- d) thoughtful
- e) myopic

27 Insert a word that means the same as the words outside the brackets.

DOG (*Boxer*) SPORTSMAN

28 What is the name given to a group of DUCKS?

- a) paddling
- b) fesnyng
- c) knob
- d) muster
- e) plump

29 Place two three-letter bits together to make a FRUIT.

ORA – PAP – PIN – PAW – PAR – PIP – AYE – NGI

Pippin

30 Circles

Which of A, B, C, D or E fits into the blank circle to carry on the sequence?

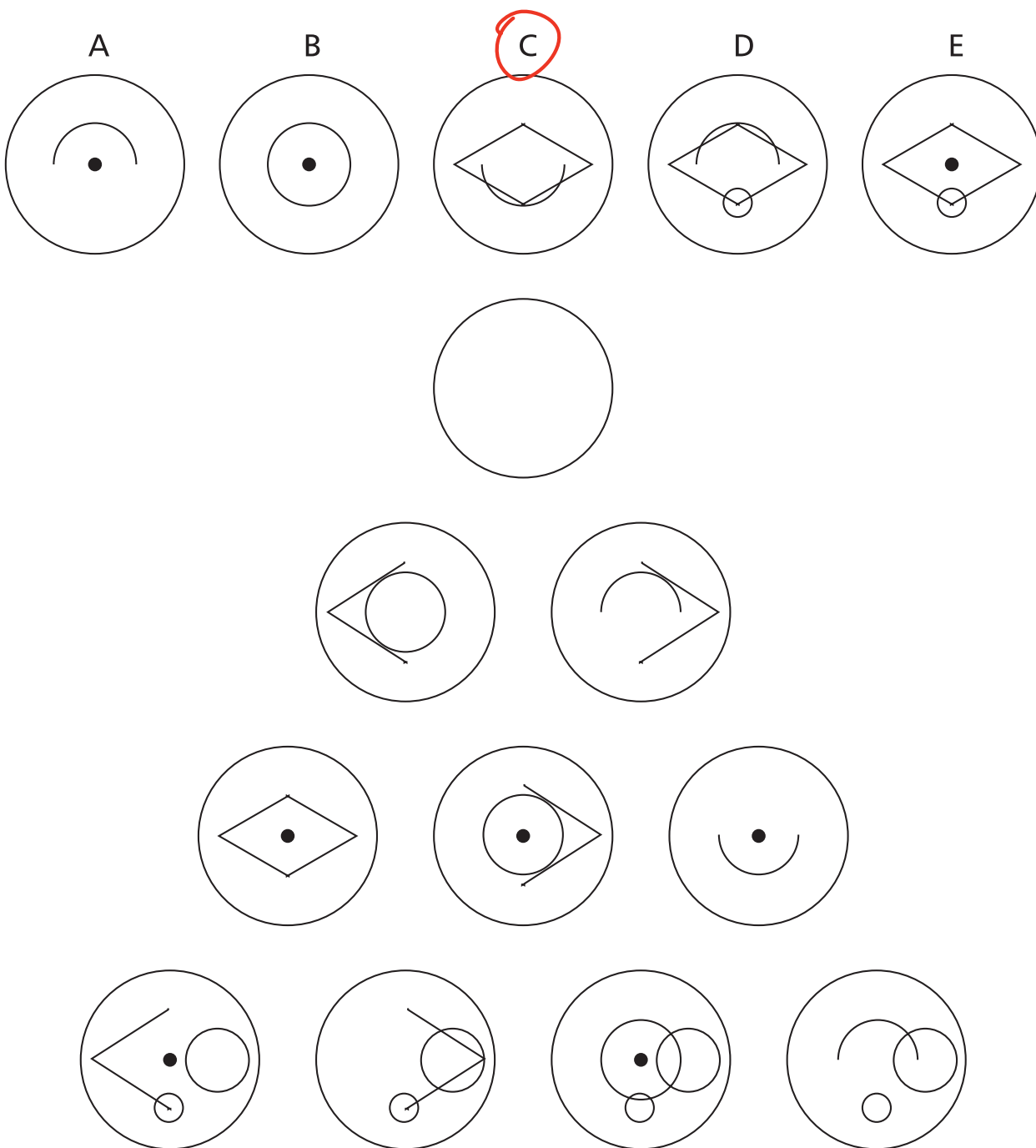

31 What number should replace the question mark?

1, 4, 13, 40, 121, ?



364

$(x3+1)$

$(x3+1)$

32 Which two words mean the same?

INDUSTRIOUS, BEARING, BUSINESS, MIEN, PANACEA, IMPIETY

Bearing Mien

33 Solve the one-word anagram.

SOBBING

Gibbons

34 What number should replace the question mark?

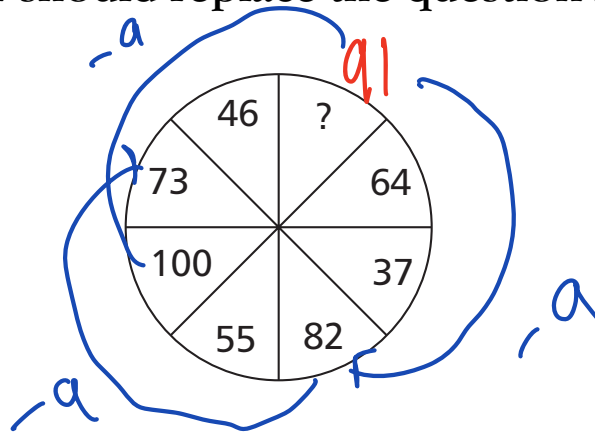

35 Symbols

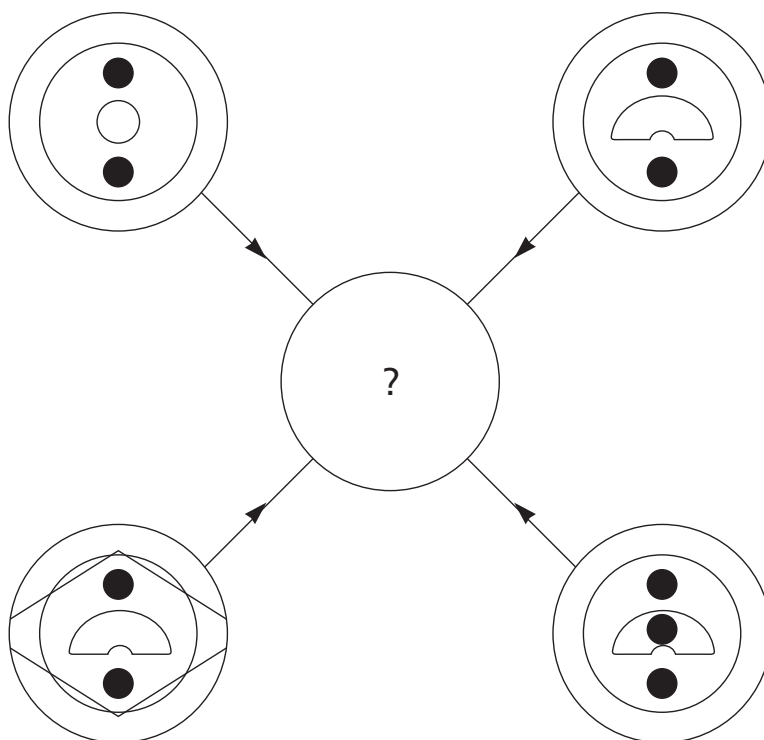

Each line and symbol that appears in the four outer circles, above, is transferred to the centre circle according to these rules:

if a line or symbol occurs in the outer circles:

- once: it is transferred
- twice: it is possibly transferred
- 3 times: it is transferred
- 4 times: it is not transferred.

Which of the circles A, B, C, D or E, shown below, should appear at the centre of the diagram, above?

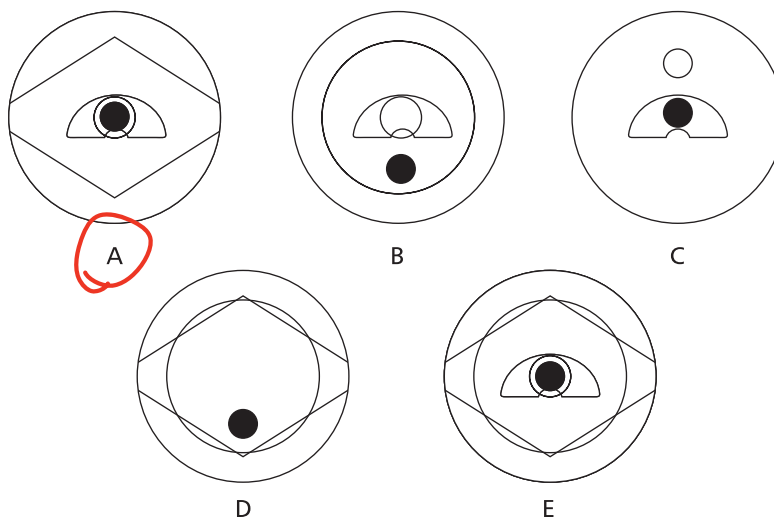

36 Which number should replace the question mark?

4, 12, $7\frac{1}{2}$, $10\frac{1}{2}$, 11, 9, $14\frac{1}{2}$, ? $7\frac{1}{2}$

37 Fill in the blanks, clockwise or anti-clockwise, to form two words that are synonyms.

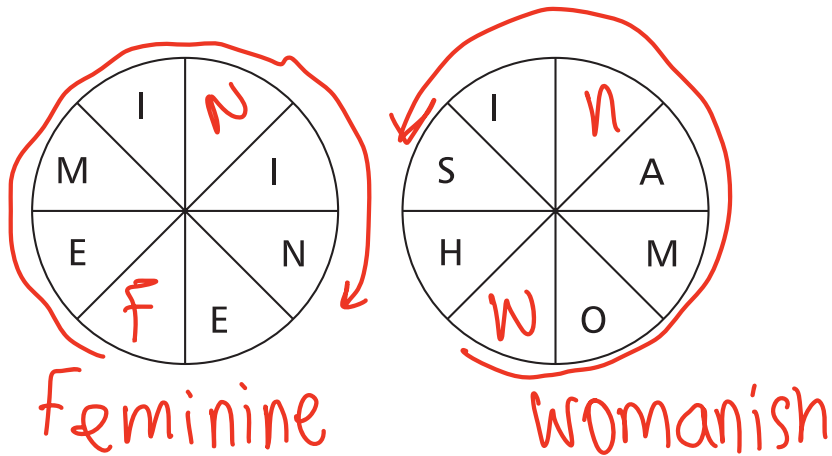

38 Find a word to replace the dots that means the same as the words outside the brackets.

WEIGHT (O.U.N.C.E) LYNX

39 Find a word to replace the dots to make five new words.

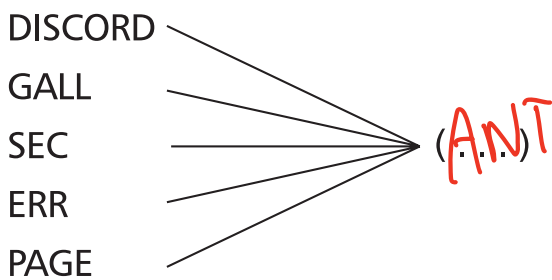

40 Circles

Which of A, B, C, D or E fits into the blank circle to carry on a logical sequence?

